

CUSTOMER'S MODEL: NO MODEL
 END COVER COLOR: GRAY

REV.	REVISION RECORD	BY	DATE
0	ORIGIN	YSX	4.11.2025

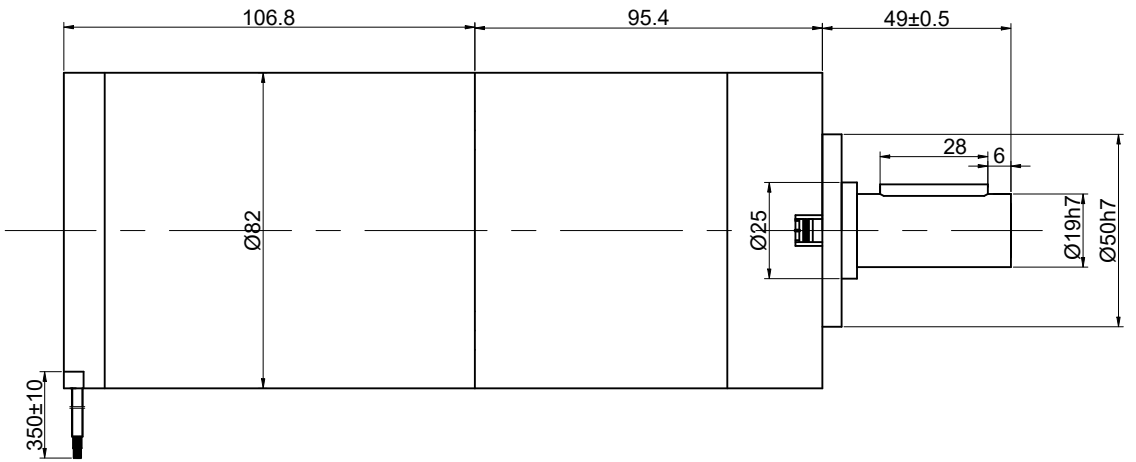
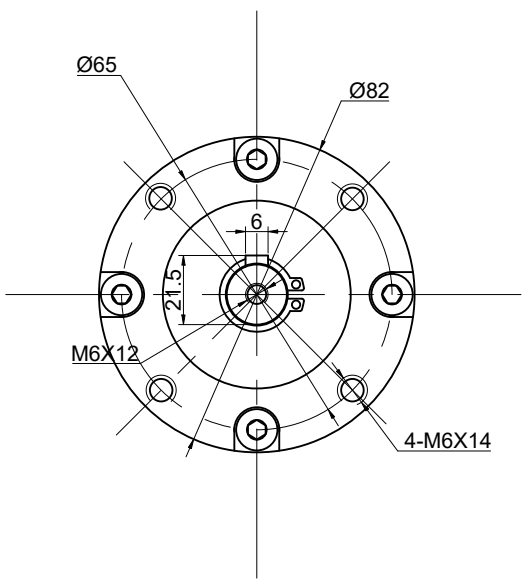

SPECIFICATION	VALUE
GEAR RATIO	71.5
NO. of PHASES	3
NO. of POLES	10
RATED VOLTAGE(V)	24
RATED TORQUE(N.m)[lb-in]	33[292.07]
RATED POWER(W)	200
RATED SPEED(RPM)	42
RATED CURRENT(A)	10.5
NO LOAD SPEED W/O GEARBOX(RPM)	4200±10%
WEIGHT(kg)	4.93
SENSOR	HALL
AMBIENT TEMPERATURE	-10°C~50°C[14°F~122°F]
INSULATION CLASS	B 130°C[266°F]
TEMPERATURE RISE	MAX.80°C

COMMENT:
 1.INSULATION RESISTANCE (NORMAL TEMPERATURE AND HUMIDITY): 50 Mohm
 2.DIELECTRIC STRENGTH: AC600V CUT OFF CURRENT 2mA FOR 1S

DIMENSIONS ARE IN MILLIMETERS.
 TOLERANCES AS BELOW:
 DECIMALS ANGLES
 X ±0.5 ±2°
 X.X ±0.25
 X.XX ±0.13

THIRD ANGLE PROJECTION

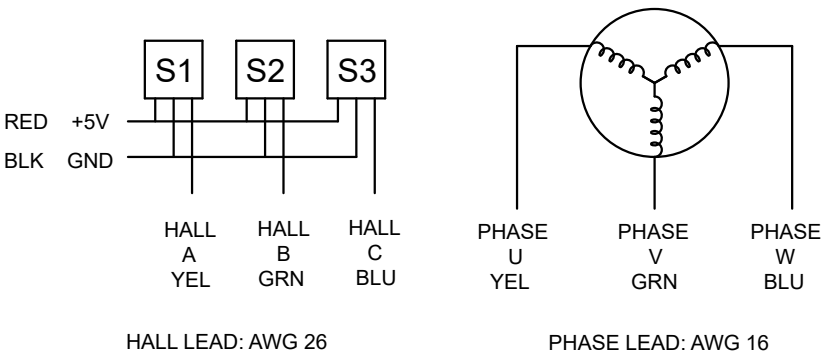

HALL LEAD: AWG 26

PHASE LEAD: AWG 16

STEPPERONLINE®

BRUSHLESS DC MOTOR

M82B200-24P-30S/G82-71.5S1

THIS DOCUMENT SHALL NOT BE REPRODUCED NOR SHALL THE INFORMATION CONTAINED HEREIN BE USED BY OR DISCLOSED TO OTHERS UNLESS EXPRESSLY AUTHORIZED IN BY WRITING STEPPERONLINE.

SIGNATURE		DATE
DRN	YSX	12.10.2025
APVD	LJ	12.10.2025

REV.	0	SCALE	1:1	DWG NO.	A4331
------	---	-------	-----	---------	-------