

CUSTOMER'S MODEL: NO MODEL
 END COVER COLOR: BLUE

REV.	REVISION RECORD	BY	DATE
0	ORIGIN	LJ	12.30.2025

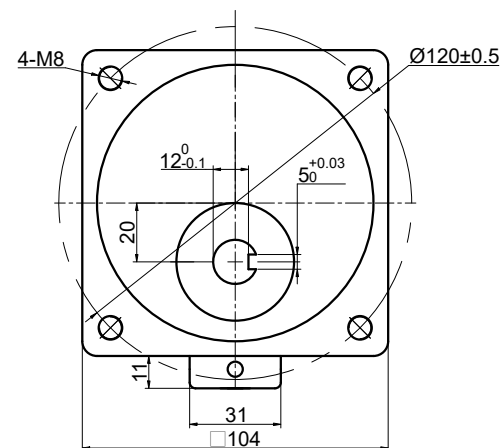
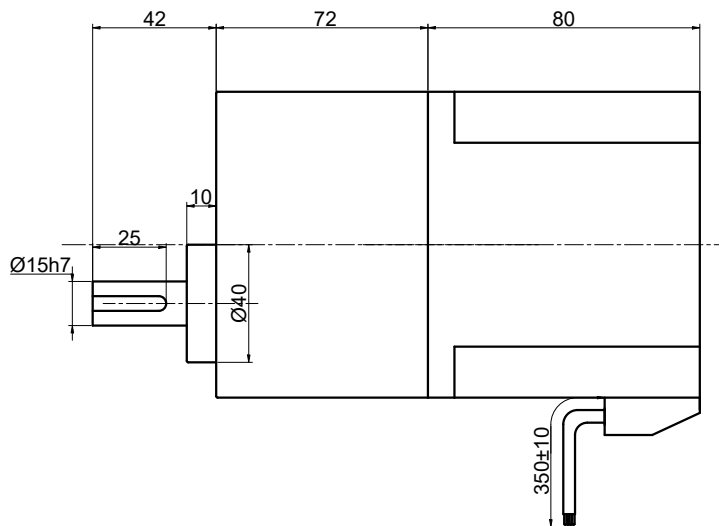

SPECIFICATION	VALUE
NO. of PHASES	3
NO. of POLES	10
RATED VOLTAGE(V):	24
RATED POWER(W):	200
RATED LOAD SPEED(RPM):	300
RATED LOAD TORQUE(N.m):	5.18
RATED CURRENT(A):	11
GEAR RATIO	10
MAX.PERMISSIBLE TORQUE(Nm)	40
AMBIENT TEMPERATURE	-10°C~40°C[14°F~104°F]
INSULATION CLASS	E 120°C[248°F]
TEMPERATURE RISE	MAX.80°C

THIS DOCUMENT SHALL NOT BE REPRODUCED NOR SHALL THE INFORMATION CONTAINED HEREIN BE USED BY OR DISCLOSED TO OTHERS UNLESS EXPRESSLY AUTHORIZED IN BY WRITING STEPPERONLINE.

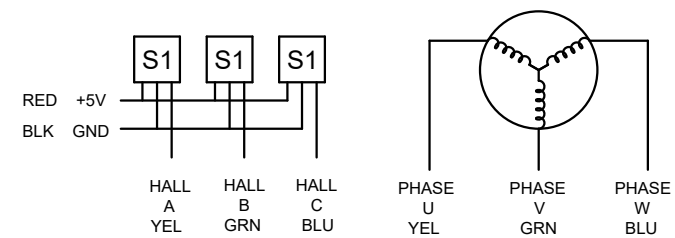

DIMENSIONS ARE IN MILLIMETERS.
 TOLERANCES AS BELOW:
 DECIMALS ANGLES
 X ±0.5 ±2°
 X.X ±0.25
 X.XX ±0.13

THIRD ANGLE PROJECTION

STEPPERONLINE®			
GEARED BLDC MOTOR			
F6B200-24GU-30S/6GU10K			
SIGNATURE	DATE	REV.	0
DRN LJ	12.30.2025	SCALE	1:1
APVD YSX	12.30.2025	DWG NO.	A5455