

CUSTOMER'S MODEL: NO MODEL
 END COVER COLOR: BLUE

REV.	REVISION RECORD	BY	DATE
0	ORIGIN	LJ	12.30.2025

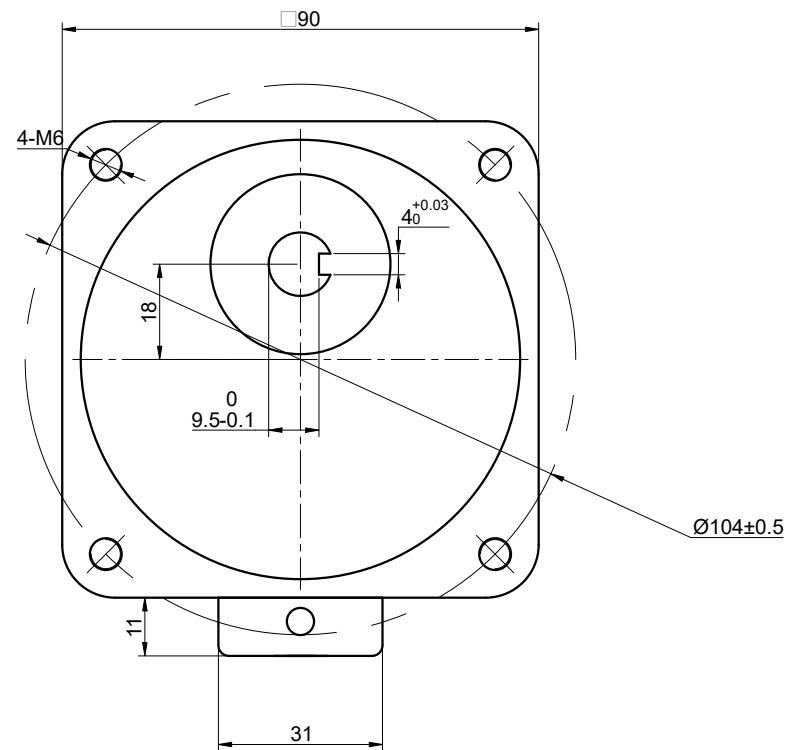
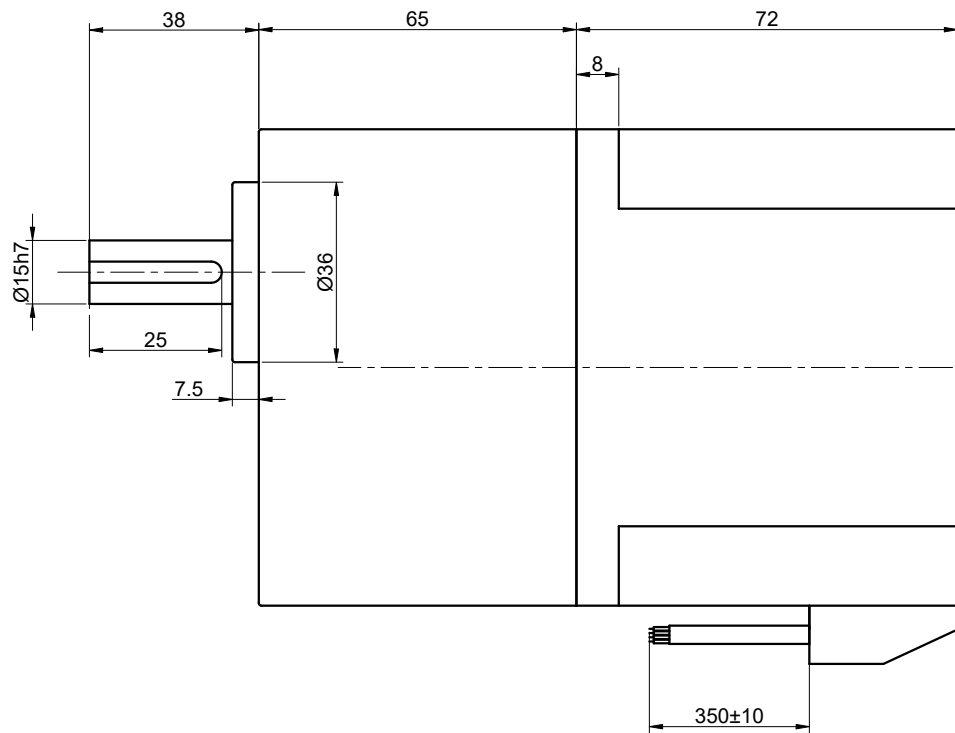

SPECIFICATION	VALUE
NO. of PHASES	3
NO. of POLES	10
RATED VOLTAGE(V):	24
RATED POWER(W):	150
RATED LOAD SPEED(RPM):	600
RATED LOAD TORQUE(N.m):	1.95
RATED CURRENT(A):	8
GEAR RATIO	5
MAX.PERMISSIBLE TORQUE(N.m)	20
AMBIENT TEMPERATURE	-10°C~40°C[14°F~104°F]
INSULATION CLASS	E 120°C[248°F]
TEMPERATURE RISE	MAX.80°C

THIS DOCUMENT SHALL NOT BE REPRODUCED NOR SHALL THE INFORMATION CONTAINED HEREIN BE USED BY OR DISCLOSED TO OTHERS UNLESS EXPRESSLY AUTHORIZED IN BY WRITING STEPPERONLINE.

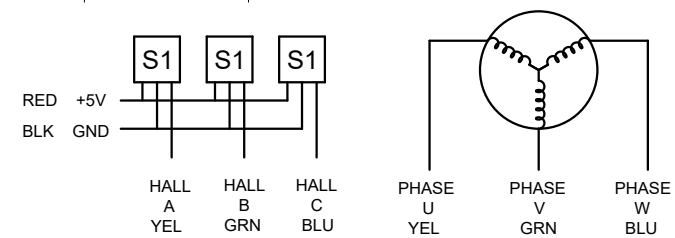

DIMENSIONS ARE IN MILLIMETERS.
 TOLERANCES AS BELOW:
 DECIMALS ANGLES
 X ±0.5 ±2°
 X.X ±0.25
 X.XX ±0.13

THIRD ANGLE PROJECTION

STEPPERONLINE®

GEARED BLDC MOTOR

F55B150-24GU-30S/5GU5KB

SIGNATURE	DATE	REV.	0	SCALE	1:1	DWG NO.	A5436
DRN	LJ	12.30.2025					
APVD	YSX	12.30.2025					