

STEPPERONLINE®

User Manual

RS485 Closed Loop Stepper Driver



©2022 All Rights Reserved

Address: 15-4, #799 Hushan Road, Jiangning, Nanjing, China

Tel: 0086-2587156578

Web: www.omc-stepperonline.com

Sales: sales@stepperonline.com

Support: technical@stepperonline.com

Notice

Read this manual carefully before any assembling and using. Incorrect handling of products in this manual can result in injury and damage to persons and machinery. Strictly adhere to the technical information regarding installation requirements.

This manual is not for use or disclosure outside of STEPPERONLINE except under permission. All rights are reserved. No part of this manual shall be reproduced, stored in retrieval form, or transmitted by any means, electronic, mechanical, photocopying, recording, or otherwise without approval from STEPPERONLINE. While every precaution has been taken in the preparation of the book, STEPPERONLINE assumes no responsibility for errors or omissions. Neither is any liability assumed for damages resulting from the use of the information contained herein.

This document is proprietary information of STEPPERONLINE that is furnished for customer use ONLY. Information in this document is subject to change without notice and does not represent a commitment on the part of STEPPERONLINE. Therefore, information contained in this manual may be updated from time-to-time due to product improvements, etc., and may not conform in every respect to former issues.

- ◆ **Thank you for purchasing STEPPERONLINE CLRS Series Products**
- ◆ **Please read this manual carefully before operating**
- ◆ **Please keep this manual appropriately**

Safety Precautions

Overall Notes



- Do not remove the housing with the drive powered on. Cables, Connectors and optional equipment.
- Please disconnect the power supply for at least 2 minutes and make sure the power indicator is off before wiring and checking. Even if the power is disconnected, voltage may remain inside the drive. Therefore, do not touch the power terminals while the power indicator is on.



- Please use the power supply specifications (number of phases.) that match the product. Voltage. Frequency. AC/DC).
- Be sure to connect the ground terminal of the driver (mounting surface) and motor to the ground pole.
- Do not damage or drag the cable, do not overstress the cable, do not hang heavy objects on the cable, or get caught in the cabinet door.
- Please do not disassemble the product yourself. Repair or modification.
- When the machine is connected to the machine and starts to operate, make sure that the machine is ready for emergency stop.
- Do not touch the inside of the drive.



- The heat sink of the driver may be hot when the power is on or when the power is just cut off. The motor, etc. may be in a high temperature. Take safety measures such as installing a cover to prevent accidental touching by hands and parts (cables, etc.).
- Use double-insulated or reinforced insulation for control power.
- Do not use in places where water can be splashed. Corrosive environments. Do not use the product in the vicinity of flammable gases and combustible materials.
- Do not use damaged. Drivers and motors with missing parts.
- Please set up an emergency stop circuit externally to ensure that the power can be cut off and the operation can be stopped immediately in case of an abnormality.
- If the product is used under poor power conditions, install protection equipment (AC reactor, etc.) to ensure that the input power is supplied within the specified voltage variation range.
- Please use a noise filter to reduce the influence of electromagnetic interference.
- The driver and motor should be used in the specified combination.

Precautions for Storage and Transportation



- Please follow the Commands on the packaging for storage and do not overload the product.
- Please place this product in the following environment:
 - No direct sunlight in the place.
 - Ambient temperature does not exceed the product specification.
 - Humidity does not exceed product specifications. Without condensation.
 - No corrosive gases. Place of flammable gas.
 - Dust. Dust. The place where there is less salt and metal powder.
 - No water. Oil. The place where the splash of medicine, etc. occurs.
 - Vibration or shock does not exceed product specifications.
 - No equipment generating strong magnetic fields in the vicinity.

Precautions for Installation



- Please install the drive in a cabinet that provides fire protection. Electrical protection in the control cabinet.
- Please install the driver and motor in a position with sufficient weight resistance.
- Please install this product in the following environment:
 - No direct sunlight in the place.
 - Ambient temperature does not exceed the product specification.
 - Humidity does not exceed product specifications. Without condensation.
 - No corrosive gases. Place of flammable gas.
 - Dust. Dust. The place where there is less salt and metal powder.
 - No water. Oil. The place where the splash of medicine, etc. occurs.
 - Vibration or shock does not exceed product specifications.
 - No equipment generating strong magnetic fields in the vicinity.
- Do not block the air inlet and exhaust ports, and do not allow foreign objects to enter the drive and motor.
- Do not step on the product or place heavy objects on the drive.
- Please install the driver in the specified direction.
- Make sure to keep the specified intervals between the inner surfaces of the drive control cabinet and other machines.

Precautions for Wiring



- Do not pass the magnetic contactor in the wiring between the drive and the motor.
- Please connect the power terminal and motor terminal firmly.
- Keep a minimum distance of 10mm between the drive and the control cabinet or other equipment.
- Allow at least 30mm of wiring space above and below the driver.
- Signal cable. The encoder cable should be a twisted shielded cable with the shield grounded at both ends.
- The wiring length of the encoder is up to 20m.
- Reduce the frequency of power on/off as much as possible.

Precautions during operation



- To prevent accidents, perform a test run of the servo motor at no load (without the driver connected).
- When you install the machine and start operation, please set the user parameters in advance to match the machine.
- Positive limit (POT) during JOG operation and zero return operation. The signal of negative limit (NOT) is not valid.
- When using the motor on a vertical axis, please provide a safety device to avoid dropping the work-piece in case of alarm or over travel.
- When an alarm occurs, please reset it after investigating the cause and making sure it is safe.
- Do not use the brake of the holding motor for normal braking.

Table of Contents

1 Introduction	1
1.1 Product Introduction	1
1.2 Features	1
1.3 Application Scenarios	1
1.3.1 Hands-on Tuning	1
1.3.2 Practical Application Scenarios	2
1.4 Check of Product	3
1.4.1 Arrival inspection	3
1.4.2 Nameplate information	3
1.4.3 Parts description	4
1.4.4 Accessories Information	4
2 Installation	5
2.1 Storage and Installation Conditions	5
2.1.1 Storage condition	5
2.1.2 Operating ambience conditions	5
2.2 Dimensions	6
2.3 Installation Direction and Space	6
3 Product Specifications	8
3.1 Electrical and Operating Specifications	8
3.1.1 Electrical and Operating Specifications	8
3.2 Wiring Instructions	9
3.2.1 Power Cable & Encoder Cable	9
3.2.2 I/O Signal Cable	9
3.2.3 RS485 Communication Cable	9
3.3 Interface Specifications	10
3.3.1 Connectors Definition	10
3.3.2 CN1 & CN2 Input Power Connector	10
3.3.3 CN3-I/O Signals Connector	11
3.3.4 CN4-RS485 Communication Connector	12
3.3.5 CN5-RS232 Tuning Port	12
3.3.6 CN6-Encoder Input Signals Connector	12
3.3.7 DIP Switches	12
3.4 I/O Connection	14
3.4.1 Digital Inputs	14
3.4.2 Digital Output	14
3.4.3 Brake Output	15
4 Modbus RTU	16

4.1 Communication Specifications	- 16 -
4.2 Modbus Function Codes (FC)	- 16 -
4.2.1 Read Holding Registers FC= 03	- 17 -
4.2.2 Preset Single Register FC= 06	- 18 -
4.2.3 Preset Multiple Registers FC= 10	- 19 -
4.3 Modbus & PR Parameters	- 20 -
4.3.1 Basic Parameters	- 20 -
4.3.2 Input and Output Parameters	- 23 -
4.3.3 Smooth Filter Time Setting for Digital Inputs	- 23 -
4.3.4 Status Monitoring Parameters	- 25 -
4.3.5 Control Word and Status Word	- 25 -
4.4 Error Codes and Troubleshooting	- 26 -
4.4.1 Communication Error Codes	- 26 -
4.4.2 Drive Alarm Codes and Troubleshooting	- 27 -
4.4.3 Error Clear	- 28 -
4.5 Register Mapping Continuous Read/Write Function	- 28 -
4.6 S-code Application	- 29 -
4.7 Enable Drive	- 30 -
5 PR Mode (Indexer Table)	- 30 -
5.1 PR Main Features	- 30 -
5.2 Homing / Return to Zero Position	- 31 -
5.2.1 Homing Parameters	- 32 -
5.2.2. Homing by Home Switch	- 33 -
5.2.3. Homing by Limit Switch	- 34 -
5.2.4 Torque zeroing.....	-34 -
5.3 Soft Limit & JOG & Quick Stop	- 35 -
5.3.1 Soft Limit	- 36 -
5.3.2 JOG	- 36 -
5.3.3 Quick Stop	- 37 -
5.4 PR Path	- 38 -
5.4.1 PR Parameters	- 38 -
5.4.2 PR Path Configuration	- 39 -
5.4.3 Other functions of PR	- 40 -
5.5 Trigger Methods	- 41 -
5.5.1 CTRG Trigger	- 41 -
5.5.2 IO Combination Trigger	- 42 -
5.5.3 Fixed Trigger	- 43 -
5.5.4 Immediate Trigger	- 44 -
6 Tuning Operations	- 45 -

6.1 Basic operation of STEPPERONLINE MotionStudio	- 45 -
6.1.1 Preparation and Steps	- 45 -
6.1.2 Operation of Trial Run	- 47 -
6.1.3 Operation of PR Function	- 48 -
6.2 Basic Operation of Serial Port Tools Software	- 50 -
6.2.1 Preparation and Steps	- 50 -
6.2.2 Operation Instruction Format.....	- 51 -
6.2.3 Command Cases of Modbus RTU.....	- 51 -
Appendix A Parameters List	- 53 -

1 Introduction

1.1 Product Introduction

CLRS Series are closed loop stepper drive based on standard Modbus RTU protocol, using RS485 communication can network up to 31 axes, built-in 16-segment position table (PR Mode --Position Register mode). They can not only solve the problem of step loss in the open loop stepper system, but also can save additional controllers in most of point-to-point applications, to greatly enhance system reliability and reduce the cost. CLRS Series also support the feature of teaching, the operation modes of Profile Position, Profile Velocity and Homing. They can power 2-phase NEMA 8, 11, 14, 17, 23, 24, 34 stepper motors with 1000 ppr to 5000 ppr incremental encoders.

The CLRS series is highly reliable and affordable and performs excellently in many industrial applications such as solar equipment, textile, civil, robotics, power generation equipment, 3C, packaging...

1.2 Features

- No loss of step, No hunting, No torque reservation
- Low noise and vibration, smooth motion
- Support Modbus RTU protocol, Internal 16-segment position instructions
- Motion can be started by External IO or RS485
- Support operation modes: Profile Position, Profile Velocity, Homing
- 7 configurable digital inputs, 3 optically isolated digital outputs
- Limit +, Limit -, Origin, Quick stop, Enable, JOG +, JOG - and Position Table inputs
- Alarm, Brake, Homing complete, In Position complete, instructions complete, Path complete outputs
- 20-50VDC supply voltage for CL57RS, max output current 7A
18-80VAC or 30-100VDC supply voltage for CL86RS, max output current 8A
- RS232 communication for parameters configuration
- Encoder resolution: 1000 ppr to 5000 ppr for NEMA8/11/17/23/24/ 34 CS-M motors
- Protections for over voltage, over current and position following error, encoder cable error, etc.

Compare with Step/Direction

- Built-in single-axis control can save the PLC in most of point-to-point applications to reduce cost;
- Built-in rich diagnostic functions and input and output signals to setup easily;
- Modbus brings more expansion possibility to add value;

1.3 Application Scenarios

Divided into simple hands-on tuning and practical application scenarios

1.3.1 Hands-on Tuning

(1) The trial run can be performed with STEPPERONLINE's MS tuning software, which requires [STEPPERONLINE's tuning software](#), [RS232 tuning cable \(provided by STEPPERONLINE\)](#), [RS232toUSB converter](#), [drive and motor](#), as described in [Section 6.1](#)

(2) Simple motion can also be performed with serial port tools, which requires [General serial port tools software](#), [RS485 tuning cable \(User-provided\)](#), [RS485toUSB converter](#), [drive and motor](#), as described in [Section 6.2](#).

1.3.2 Practical Application Scenarios

(1) Controlled by Modbus RS485 (PLC or HMI)

The RS485 (Modbus-RTU protocol) communication triggers the drive's PR motion register, which can realize the drive's path motion. [Both PLC and HMI have RS485 communication so user can choose one or both.](#) Using PLC can write more complex programs to let motion more intelligent, and the HMI can monitor and modify the drive parameters in real time.

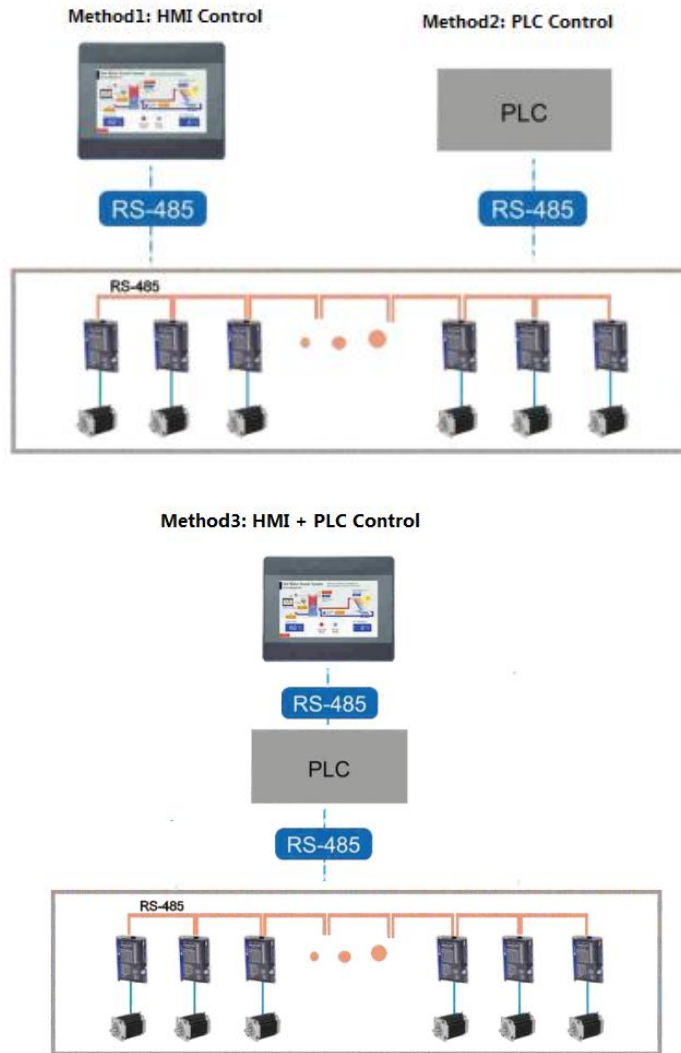

(2) Controlled by I/O (switch signal or PLC)

The user only needs to turn off the switch signal to realize the PR motion, which is simple to control and low-cost design.

User can also use PLC I/O module to realize PR motion, which is more intelligent than switch signal control.

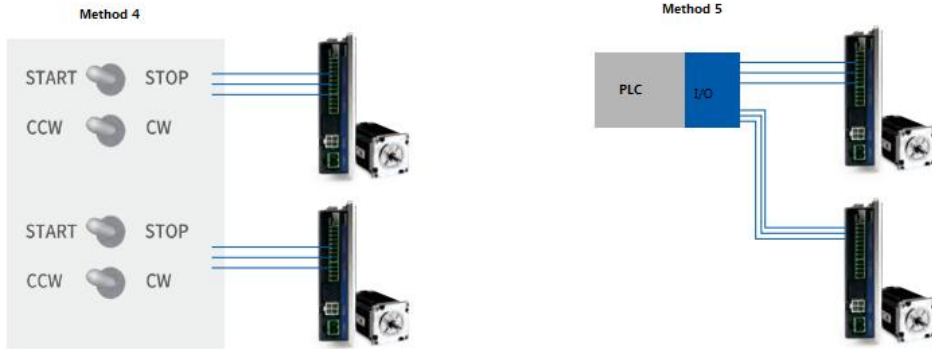

1.4 Check of Product

1.4.1 Arrival inspection

- Check whether the surface of the product is damaged or not during transportation.
- Check the nameplate models of the drive and motor are what you have ordered.
- Check if it is fully equipped with accessories. Accessories include power supply and I/O signals connector.



- Neither the damaged nor missing accessories of stepper system is allowed to install.
- Contact STEPPERONLINE or local distributor if any failure was found.

1.4.2 Nameplate information



1.4.3 Parts description

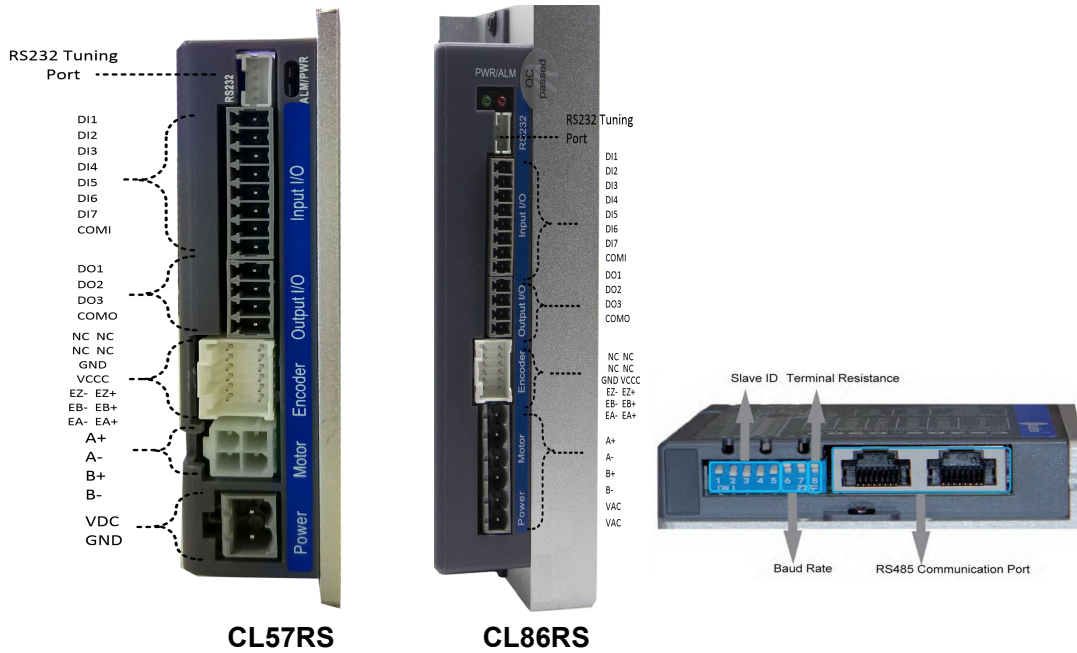

1.4.4 Accessories Information

Name	Necessary	Picture	Description	Need to cost extra
Housing and terminal for driver side of motor cable	Yes		Manufacturer: Molex Housing: 39012040 Terminal: 39000038. CL66RS doesn't need.	No
Housing and terminal for driver side of encoder cable	Yes		Manufacturer: Molex Housing: 513531200 Terminal: 561349000	No
Tuning Cable	No		CABLE-PC-1 cable	Yes
Network cable	Yes		Optional length: 0.1m, 0.2m, 0.3m, 0.4m, 1m, 1.5m, 2m, 3m, 5m, 7m, 10m, 15m, 20m	Yes

Note:

- (1) Tuning cable is not necessary it can also modify parameters by controller PC software.
- (2) Network cable is necessary but you can also buy shielded network cable through 3rd party.

2 Installation

2.1 Storage and Installation Conditions

2.1.1 Storage condition

- Correctly packaged and store in a clean and dry environment where direct sunlight is avoided.
- Store within an ambient temperature ranging from -20°C to +65°C.
- Store within a relative humidity ranging from 40% to 90% and non-condensed.
- Avoid any type of exposure to corrosive gases.

2.1.2 Operating ambience conditions

- Temperature ranging from 0°C to 50°C. The ambient temperature of drive for long-term reliability should be under 40°C. Please install the drive in a well-ventilated area.
- Operation within a relative humidity ranging from 40% to 90% and non-condensed.
- Vibration lower than 0.15mm at a frequency of 10Hz-55Hz.



- DO NOT mount the drive and motor in a location subjected to corrosive or flammable gases, and combustibles.
- Please mount the drive and motor in an indoor electric control cabinet without liquid where direct sunlight is avoided.
- DO NOT mount the drive and motor in a location subjected to airborne dust.
- Please ensure grounding wires are securely connected

2.2 Dimensions

Unit: mm (1inch=25.4mm)

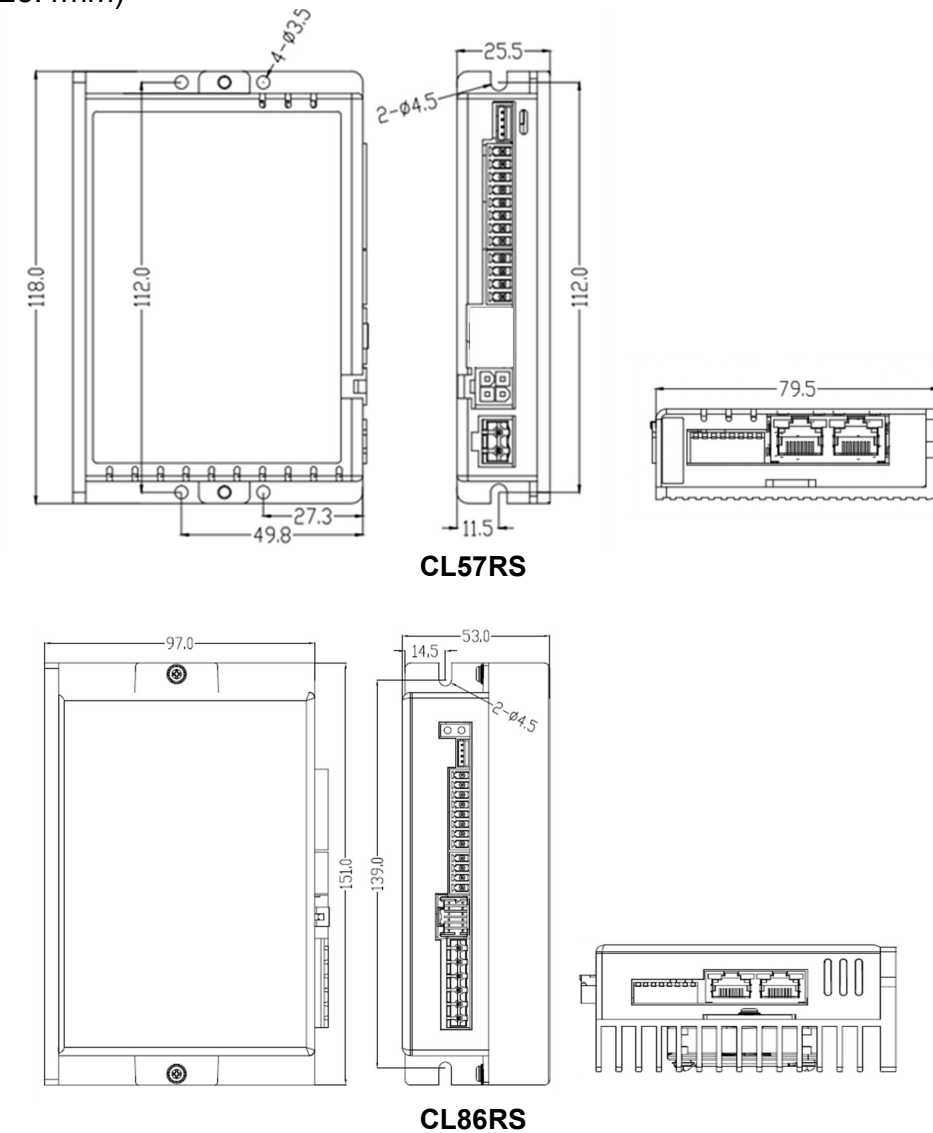

Figure 2.1: CLRS series mechanical drawing

2.3 Installation Direction and Space

- The mounting of drive, wiring and motor should be under the regulations of EN 61800-5-1.
- Incorrect installation may result in a drive malfunction or premature failure of the drive and /or motor. Please follow the guidelines in this manual when installing
- The drive should be mounted perpendicular to the wall or in the control panel.
- In order to ensure the drive is well ventilated, ensure that the all ventilation holes are not obstructed and sufficient free space is given to the drive, and a cooling fan is mounted in the control panel.
- Please ensure grounding wires are securely connected.

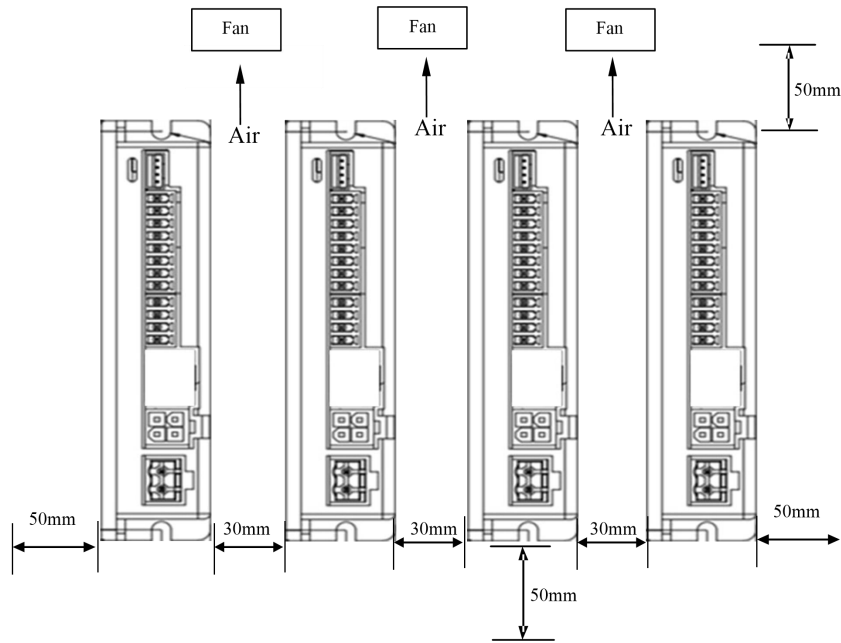

Figure 2.2: CLRS series installation drawing

3 Product Specifications



- Don't hot plug the motor wiring, encoder wiring and RS232 communication wiring during power on.
- Be sure to check the connections and make sure the power lead polarity is correct, or there could result in injury or fire.
- Be sure wait for 5 minutes or longer to touch drives after turning off power
- Be sure to give the power supply voltage dose not exceed the drive's input range.
- If using a motor with small phase current, be sure to modify the driver output current before enabling the motor

3.1 Electrical and Operating Specifications

3.1.1 Electrical and Operating Specifications

Name	CL57RS	CL86RS
Supply Voltage	20-50VDC	30-110VDC or 18-80VAC
Output Current (Peak)	1.0-7.0A	2.1-8.0A
Size (H*W*L mm)	118*79.5*25.5	151*97*53
Weight (kg)	0.65	0.92
Matched Motor	NEMA 17, 23, 24	NEMA34
Input Signals	Limit +, Limit -, Origin, Quick stop, Enable, JOG +, JOG - and Position Table	
Output Signals	Brake, Alarm, In Position, GPIOs	
Protection Functions	Over Current, Over Voltage, Position Following Error, Encoder Cable Error, etc.	
PC Software	STEPPERONLINE ProTuner (coming soon)	
Operating Environment	Environment	Avoid dust, oil ,fog and corrosive gases
	Operating Temperature	0-50°C (32 F – 122 F)
	Storage Temperature	-20°C-65°C (-4 F – 149 F)
	Humidity	40-90%RH
	Vibration	10-55Hz/0.15mm
	Mount	Vertical or horizontal mounting

3.2 Wiring Instructions

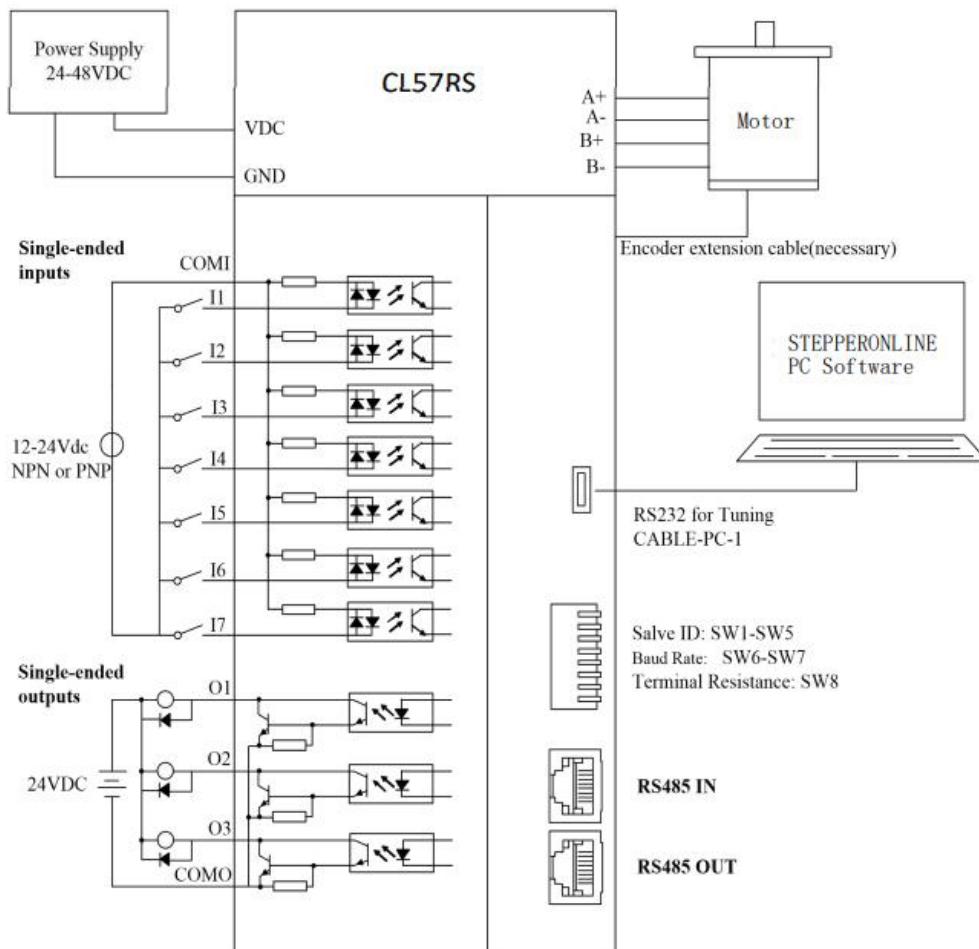

Figure 3.1 Wiring Instructions

Note:

- (1) There are two RS485 communication ports one of them is input port which connects with master station or previous slave, and another is output port which connects with the following slave.
- (2) Single-ended inputs I1, I2, I3, I4, I5, I6 and I7 connection types can be common-cathode and common-anode.
- (3) Single-ended outputs connection type is common-anode.

3.2.1 Power Cable & Encoder Cable

- +VDC, GND, A+, A-, B+, B- terminal wire diameter $\geq 0.3\text{mm}^2$ (AWG15-22);
- EA+, EA-, EB+, EB-, EZ+, EZ-, VCC, GND wire diameter = 0.15mm^2 (AWG26)
- Recommend to adopt shielded twisted pair cables.

3.2.2 I/O Signal Cable

- Wire diameter: I1 - I7, O1 - O3, COM wires diameter $\geq 0.12\text{mm}^2$ (AWG24-26)
- Recommend to adopt shielded twisted pair cable with length of less than 3 meters (the shorter, the better).
- Wiring: As far as possible away from the power line wiring, in order to prevent interference
- Please connect surge to absorbe inductive device, such as anti-parallel diode for DC coil, parallel RC-snubbers circuit for AC coil.

3.2.3 RS485 Communication Cable

It is recommended to use shielded Ethernet network cables which do not exceed 100 meters.

3.3 Interface Specifications

3.3.1 Connector Definition

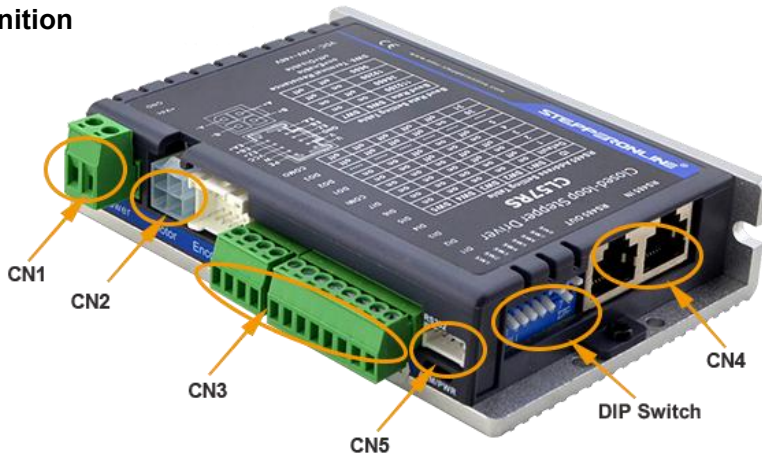

Figure 3.2: CLRS series connectors

Name	Description
CN1	Input power connector
CN2	Motor connector
CN3	I/O signals connector
CN4	RS485 communication connector
CN5	RS232 tuning connector
CN6	Encoder Signals Connector
DIP Switch	Salve ID: SW1-SW5 Baud Rate: SW6-SW7 Terminal Resistance: SW8

3.3.2 CN1 & CN2 Input Power Connector

■ **CL57RS**

Name	Pic	PIN	Signal	Description
CN1		1	VDC	24V- 48V
		2	GND	GND
CN2		4	A+	Motor phase A+
		3	B+	Motor phase B+
		2	A-	Motor phase A-
		1	B-	Motor phase B-

■ **CL86RS**

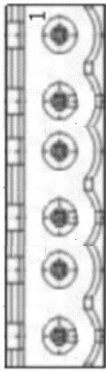
Name	Pic	PIN	Signal	Description
CN1&CN2		1	A+	Motor phase A+
		2	B+	Motor phase B+
		3	A-	Motor phase A-
		4	B-	Motor phase B-
		5	AC	18-80VAC or 30-110VDC no polarity
		6	AC	

Note: When the user uses an AC transformer to supply power,
Be sure to use an isolation transformer to prevent electric shock or burn out the computer.

3.3.3 CN3-I/O Signals Connector

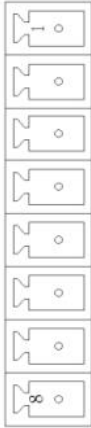
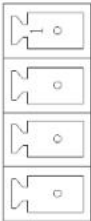
Name	Pic	PIN	Signal	I/O	Description
CN4		1	DI1	I	Configurable Single-ended Digital Inputs DI1-DI7, 12V - 24V. DI1 is enabling signal default, DI2-DI7 are GPIOs.
		2	DI2	I	
		3	DI3	I	
		4	DI4	I	
		5	DI5	I	
		6	DI6	I	
		7	DI7	I	
		8	COMI	I	
		9	DO1	O	Configurable Single-ended Outputs Signals DO1-DO3 (common-cathode or common-anode), Max. 24V/100mA, GPIOs.
		10	DO2	O	
		11	DO3	O	
		12	COMO	O	

Note:(1) DI or DO is shown as SI or SO in STEPPERONLINE MotionStudio.

(2) DI1 is normally closed, default by Enable signal. It means the motor is locked shaft after the driver powered on.

(3) When using brake output signals you need to connect a relay and a diode.

3.3.4 CN4-RS485 Communication Connector

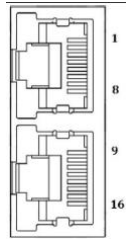
Name	Pic	PIN	Signal	Description
CN4		1	RS485+	RS485 TxD+
		9		RS485 RxD+
		2	RS485-	RS485 TxD-
		10		RS485 RxD-
		5, 6, 13, 14	GND	GND
		7, 8, 15, 16, 3, 4, 11, 12	NC	Reserved
		Connector cover	PE	Shield GND

3.3.5 CN5-RS232 Tuning Port

Name	Pic	PIN	Signal
CN5		1	NC
		2	TxD
		3	GND
		4	RxD

3.3.6 CN6-Encoder Input Signals Connector

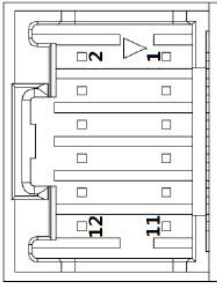
Name	Pic	PIN	Signal	Description
CN6		1, 2, 3, 4	NC	Reserved
		5	VCC	Encoder +5V voltage
		6	GND	Encoder ground
		7	EZ+	Encoder Z+ signal (optional)
		8	EZ-	Encoder Z- signal (optional)
		9	EB+	Encoder signal of phase B+
		10	EB-	Encoder signal of phase B-
		11	EA+	Encoder signal of phase A+
12	EA-	Encoder signal of phase A-		

3.3.7 DIP Switches

The CLRS series drives use an 8-bit DIP switched to set Salve ID (also called Site Alias), Baud Rate and Terminal Resistance, they are shown as below:



(1) Slave ID: SW1-SW5 (off=1, on=0)

Slave ID	SW1	SW2	SW3	SW4	SW5
1 (default)	on	on	on	on	on
1 (factory)	off	on	on	on	on
2	on	off	on	on	on
3	off	off	on	on	on
4	on	on	off	on	on
5	off	on	off	on	on
6	on	off	off	on	on
7	off	off	off	on	on
8	on	on	on	off	on
9	off	on	on	off	on
10	on	off	on	off	on
11	off	off	on	off	on
12	on	on	off	off	on
13	off	on	off	off	on
14	on	off	off	off	on
15	off	off	off	off	on
16	on	on	on	on	off
17	off	on	on	on	off
18	on	off	on	on	off
19	off	off	on	on	off
20	on	on	off	on	off
21	off	on	off	on	off
22	on	off	off	on	off
23	off	off	off	on	off
24	on	on	on	off	off
25	off	on	on	off	off
26	on	off	on	off	off
27	off	off	on	off	off
28	on	on	off	off	off
29	off	on	off	off	off
30	on	off	off	off	off
31	off	off	off	off	off

Note: (1) When the SW1-SW5 is default (all are on), the Slave ID can be configured by the PC software

(2) Baud Rate: SW6 - SW7

Baud Rate	SW6	SW7
115200 (Default)	on	on
38400 (Factory)	off	on
19200	on	off
9600	off	off

Note: (1) When the SW6-SW7 is default (all are off), the Baud Rate can be configured by the PC software

(3) Terminal Resistance Selection: SW8

SW8=ON: terminal resistance is valid;

SW8=OFF: terminal resistance is invalid (factory setting)

Note: (1) The last slave in the network needs to connect a 120Ω terminal resistance, it means set the SW8 to on

3.4 I/O Connection

3.4.1 Digital Inputs

The connections of input signals are as below:

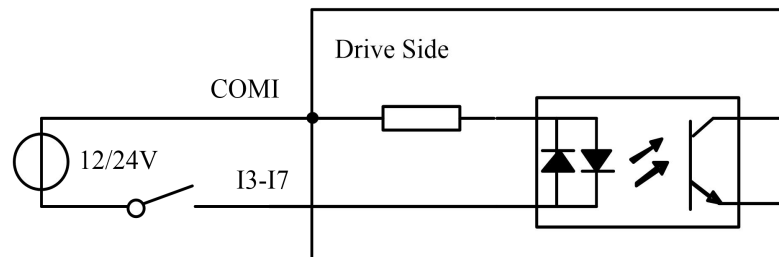

COMI: can be connected to 12 / 24 V (common-anode), or 0 V (common-cath)

Figure 3.3: Input Interface Connection

3.4.2 Digital Output

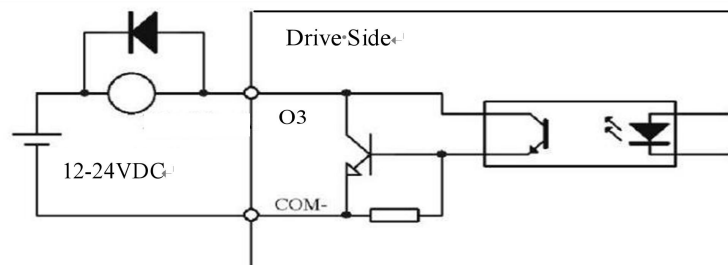

Figure 3.4: Output Interface Wiring

Note:

(1) The power supply (12-24VDC) above is provided by user, and if the polarity of power supply is reversed it will damage the drive.

(2) Digital output is OC output with the maximum capacity of 100mA/24V (recommended 50mA/24V), the provided power supply should be under 30V (recommended 24V), otherwise it will cause damage to the drive.

3.4.3 Brake Output

Use PC software (from STEPPERONLINE or Controller or PLC vendor) to configure this output as a BRAKE CONTROL output. In this case, brake signal can be used for automatic brake control while system power failure. It is recommended to connect a fly-wheel diode in parallel to a 24VDC relay and brake coil connection. Refer to the following figure for brake connections.

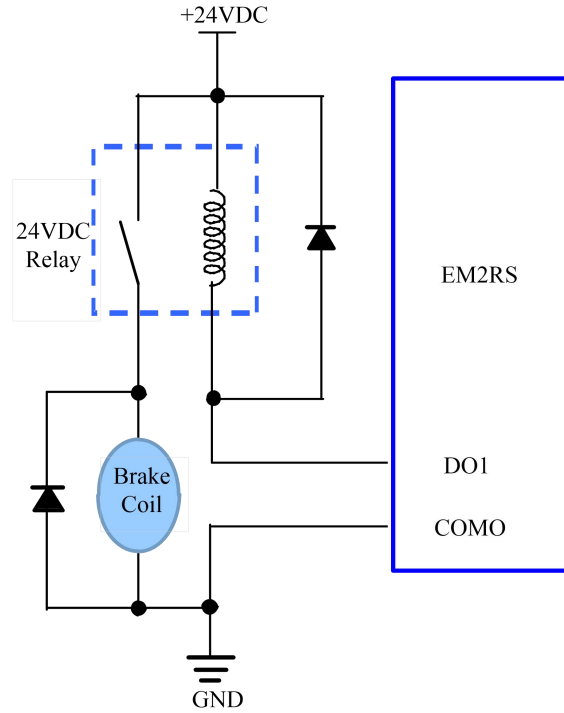

Figure 3.5: Brake output connection

4 Modbus RTU

4.1 Communication Specifications

Items		Specifications		Remarks	
Communication	Communication Port	RS485 and RS232		RS232 only for fine tuning RS485 for motion control	
	Baud Rate	9600/19200/38400/115200[bps]		Parameter setting	
	Synchronous Mode	Start / Stop Synchronization		-	
	Communication Mode	Half-duplex, Master-slave Mode		Slave/slave communication is prohibited	
	Character Composition	Starting bit:1bit Data length:8bit Check bit:even/ odd/ no Stop bit:0/1/2		Parameter setting	
Protocol	Communicating Protocol	Modbus RTU		ASCII is not supported	
	Slave ID	0:broadcast 1-31:valid sub-devices Numbers		Parameter setting	
	Function code (FC)	Function code (FC)	Function		-
		0x03	Read single or multiple data		
		0x06	Write value to single data		
		0x10	Write value to multiple data		
	Check Mode	CRC-16		Left is Low-bit, Right is high-bit	
Message Length	Variable, the max length is 200byte		-		

Single message communication rate of RS485: (Unit: ms)

Baud rate	Start receiving to send completion time	Receive wait time	Time from transmission completion to recovery of receiving state	Total
115200	2.44	0.64	0.6	3.08
38400	5.5	1.16	0.46	7.12
19200	10.76	2.2	0.38	13.34
9600	20.5	3.8	0.6	24.9

4.2 Modbus Function Codes (FC)

The current supported function codes as below:

Function Code (FC)	Type	Description
03	Read Holding Registers	Requests content of holding registers
06	Preset Single Register	Writes to single holding register
10	Preset Multiple Registers	Writes to multiple holding register

4.2.1 Read Holding Registers FC= 03

Read Holding Registers Query (Master to Slave)		Read Holding Registers Response (Slave to Master)	
Slave ID	00 - 1F	Slaver ID	00 - 1F
FC	03	FC	03
Address of beginning register to be read	High	Number of data bytes in message	2 bytes per register
	Low		
Total number of registers to be read	High	Data from registers (2 bytes per register)	High
	Low		Low
CRC	Low	CRC	Low
	High		High

Example A: Read the value of a single register--peak current

Send message: 01 03 01 91 00 01 D4 1B

Receive message: 01 03 02 00 0A 38 43

Details as following: Master->slave data:

Message:	01	03	01 91	00 01	D3 1B
Description:	Slave ID	FC	Register address	Number of registers read	CRC

Slave->master data:

Message:	01	03	02	00 0A	38 43
Description:	Slave ID	FC	Number of bytes returned	Value of 0x01 91	CRC

Note: 0x0191-- output peak current, 000A(Hexadecimal)=10(decimal, unit: 0.1A), it means the current 1A.

Example B: Read multiple register values

Send message: 01 03 01 BC 00 06 05 D0

Receive message: 01 03 0C 00 00 00 02 00 00 00 01 00 00 00 04 B6 13

Details as following: Master->slave data:

Message	01	03	01 BC	00 06	05 D0
Description	Slave ID	FC	Register address	Number of registers read	CRC

Slave>master data:

Message	01	03	0C	00 00	00 02	00 00	00 01	00 00	00 04	9D B3
Description	Slave ID	FC	Number of bytes returned	Value of 0x01BC	Address 0x01BD	Value of 0x01BE	Value of 0x01BF	Value of 0x01C0	Value of 0x01C1	CRC

Note:

(1) The above example shows reading the value of Pr5.22, Pr5.23, Pr5.24, their corresponding address are 0x01BD, 0x01BF, 0x01C1.

(2) The data type of parameter is 32bit ,which include high 16bit register and low 16bit register. Usually, we use low 16bits only, but it needs to take the high 16 bits as beginning when we read/write multiple parameters continuously.

4.2.2 Preset Single Register FC= 06

Preset Single Register Query (Master to Slave)		Preset Single Register Response (Slave to Master)	
Slave ID	00 -- 1F	Slaver ID	00 -- 1F
FC	06	FC	06
Address of register to write to	High	Address of register written to	High
	Low		Low
Value to write	High	Value written to register	High
	Low		Low
CRC	Low	CRC	Low
	High		High

Example C: Write the value of a single register--peak current

Send message: 01 06 01 91 00 20 D8 03

Receive message: 01 06 01 91 00 20 DD 7B

Details as following:

Master->slave data:

Message	01	06		01 91	00 20	DD 7B
Description	Slave ID	FC		Register address	Write data	CRC

Slave>master data:

Message	01	06	01 91	00 20	DD 7B
Description	Slave ID	FC	Register address	Write data	CRC

Note: 0x0191-- output peak current, write data 0x0020=32(decimal, unit: 0.1A), it means the current 3.2A.

Example D: Save the written value to EEPROM

Send message: 01 06 18 01 22 11 06 06

Receive message:01 06 18 01 22 11 06 06

Details as following:

Master->slave data

Message:	01	06	18 01	22 11	06 06
Description	Address	Function code	Register address	Write data	CRC check code

Slave>master data:

Message:	01	06	18 01	22 11	06 06
Description	Address	Function code	Register address	Write data	CRC check code

Note: 0x1801-- Auxiliary control word, and 0x2211 is to save the value to EEPROM. This step is required after the parameter has been modified, to prevent losing the written value after power-off.

4.2.3 Preset Multiple Registers FC= 10

Preset Multiple Registers Query (Master to Slave)		Preset Multiple Registers Response (Slave to Master)	
Slave ID	00 - 1F	Slaver ID	00 - 1F
FC	10	FC	10
Address of first register to write to	High	Address of first register written to	High
	Low		Low
Total number of registers to write to	High	Total number of registers written to	High
	Low		Low
Number of data bytes in message	2 bytes per register	CRC	Low
Value1 to write	High		High
	Low		
Value2 to write	High		
	Low		
CRC	Low		
	High		

Example E: Write multiple registers-- configure input port functions

Send message:01 10 01 46 00 04 08 00 00 00 28 00 00 00 29 1C 14

Receive message:01 10 01 46 00 04 21 E3

Details as following:

Master->slave data:

Message	01	10	01 46	00 04	08	00 00, 00 28, 00 00, 00 29	1C 14
Description	Slave ID	FC	First address write	Number of address write	Number of bytes	Value to write	CRC

Slave>master data:

Message	01	10	01 46	00 04	21 E3
Description	Slave ID	FC	First address write	Number of address write	CRC

Note: (1) In above example, modify the function of DI2 / DI3, and write the value as DI2=0x28 (means path 0), DI2=0x29 (means path 1);

(2) The data type of parameter is 32bit, which include high 16bit register and low 16bit register, usually we use low 16bits only, but it needs to take the high 16 bits as beginning when we read/write multiple parameters continuously.

4.3 Modbus & PR Parameters

4.3.1 Basic Parameters

STEPPERONLINE RS485 parameter data type is 32 bits, a parameter contains two registers of high 16 bits and low 16 bits, only the lower 16 bits are used in practice. However, when reading or writing multiple parameters in succession, the high 16 bits of the parameter need to be used as the start, usually 00.

Register Address	Software Par. #	Name	Description	Range	Default Value	Unit
0x0001	Pr0.00	Pulse/revolution	10000	200-51200	10000	P/R
0x0003	Pr0.01	Control Mode	Value "0" for open loop; Value "2" for closed loop; Value "1" is reserved.	0-255	2	--
0x0007	Pr0.03	Motor direction	0: CW 1: CCW	0-1	0	--
0x0009	Pr0.04	Motor inductance	Invalid	0-10000	1499	0.001mH
0x000B	Pr0.05	Allowed max position following error	It's used to set the allowed max pulse count of position errors.	0-65535	4000	CPR
0x00F	Pr0.07	Forced enable by software	Software forced enable has a higher priority than IO enable, and when this value is 0, the enable status of the drive only depends on the IO signal. When this value is 1, the motor is enabled regardless of the IO signal status.	0-1	0	--
0x0051	Pr1.00	Position loop Kp	Increase this value will reduce position following error, but could result in motor vibration	0-3000	507:25 1008: 45	--
0x0053	Pr1.01	Velocity loop Ki	This parameter is used for tuning Velocity loop proportional gain.	0-3000	3	--
0x0055	Pr1.02	Velocity loop Kp	Increase the value can increase velocity stiffness	0-3000	507: 25 1008: 45	--
0x0065	Pr1.10	Position loop KpH	Usually keep default	0-3000	0	--
0x00A1	Pr2.00	Command filter time	To configure the time for internal command filtering	0-512	15	0.1ms
0x00A3	Pr2.01	Velocity switching point: open loop to closed loop	Usually keep the default value. Only change it when it causes motor vibration at this mode switching velocity point.	0-200	18	0.1RPS
0x00A5	Pr2.02	Velocity switching point: closed loop to open loop	Usually keep the default value.	0-200	12	0.1RPS
0x00A7	Pr2.03	Delay time of open loop to closed loop	Usually keep the default value.	0-32767	5	ms
0x00A9	Pr2.04	Delay time of closed loop to open loop	Usually keep the default value.	0-32767	250	ms
0x0145	Pr4.02	SI1(input 1)	Default is normal-open (N.O) type, it can be set to normal-closed (N.C) type by setting the corresponding port +0x80 SI1 is enable(default), N.C type input. 0: invalid; 7: alarm clearing; 8: enable (also can be set by 0x00F); 0x20: Trigger command (CTRG); 0x21: Trigger homing; 0x22: EMG (quick stop); 0x23: JOG+; 0x24: JOG-; 0x25: POT (positive limit); 0x26: NOT (negative limit); 0x27: ORG (home switch); 0x28: ADD0 (path address 0);	0-65535	136 (0x88)	--
0x0147	Pr4.03	SI2(input 2)		0-65535	0	--
0x0149	Pr4.04	SI3(input 3)		0-65535	0	--
0x014B	Pr4.05	SI4(input 4)		0-65535	0	--
0x014D	Pr4.06	SI5(input 5)		0-65535	0	--
0x014E	Pr4.07	SI6(input 6)		0-65535	0	--
0x014F	Pr4.07	SI6(input 6)		0-65535	0	--

0x0151	Pr4.08	SI7(input 7)	0x29: ADD1 (path address 1); 0x2A: ADD2 (path address 2); 0x2B: ADD3 (path address 3); 0x2C: JOG velocity 2	0-65535	0	--
0x0157	Pr4.11	SO1(output 1)	Default is normal-open(N.O) type, it can be set to normal-closed(N.C) type by setting the corresponding port +0x80 0: invalid; 0x20: command completed; 0x21: path completed; 0x22: homing completed; 0x23: in-position completed; 0x24: brake output; 0x25: alarm output;	0-65535	0	--
0x0159	Pr4.12	SO2(output 2)		0-65535	0	--
0x015B	Pr4.13	SO3(output 3)		0-65535	0	--
0x0167	Pr4.19	Delay of brake released	Keep default normally	0-1500	250	ms
0x0169	Pr4.20	Delay of brake locked	Keep default normally	0-1500	250	ms
0x016B	Pr4.21	Threshold value of brake locking velocity	Keep default normally	0-500	10	--
0x016D	Pr4.22	Alarm detection selection	Bit setting: =1: Yes; =0: No bit0: over-current (Cannot be changed) bit1: over-voltage bit2: Position following error bit3: ADC sampling failure bit4: locked shaft alarm bit5: EEPROM alarm bit6: auto-tuning alarm	0-65535	0	--
0x0171	Pr4.24	Distance to send "In Position" output signal	The distance (in number of pulses) to send out the In-Position signal	0-1500	200	CPR
0x0177	Pr4.27	Bus voltage		0-65535	0	0.1V
0x0179	Pr4.28	Digital input statue	Bit0-Bit6: SI1-SI7	0-65535	0	--
0x017B	Pr4.29	Digital output statue	Bit0-Bit2: SO1-SO3	0-65535	0	--
0x0187	Pr4.35	DIP switches statue	--	0-65535	0	--
0x0191	Pr5.00	Peak current	Approximately equal to motor phase current value multiplied by 1.2 -1.4	503: 3-30 507: 5-70 1008: 5-80	503: 25 507: 60 1008: 80	0.1A
0x0193	Pr5.01	Percentage of holding current in closed-loop mode	It is recommended to keep default, If the torque is not enough, it can be increased appropriately	0-100	50	%
0x0195	Pr5.02	Percentage of holding current in open-loop mode	It is recommended to keep default, If the torque is not enough, it can be increased appropriately	0-100	50	%
0x0197	Pr5.03	Percentage of shaft locked current(power on)	Keep default normally	0-100	100	--
0x0199	Pr5.04	Shaft locked duration	Keep default normally	0-1500	200	1ms
0x019F	Pr5.07	Rising time of shaft locked current (power on)	Keep default normally	1-60	1	100ms
0x01A5	Pr5.10	The max stop time	Keep default normally	100-1000	1000	ms
0x01AB	Pr5.13	Auto-tuning at power on	0: disable, 1: enable	0-1	1	--
0x01BD	Pr5.22	RS485 baud rate	0: 2400 1: 4800 2: 9600 (default) 3: 19200 4: 38400(factory) 5: 57600 6: 115200 When SW6 and SW7 are all OFF, it can be set by PC software.	0-6	4	--
0x01BF	Pr5.23	RS485 ID	When SW1 - SW5 are all ON, it can be set by PC software	0-127	1	--
0x01C1	Pr5.24	RS485 data type selection	0: 8-bit data, even check, 2 stop bits; 1: 8-bit data, odd check, 2 stop bits 2: 8-bit data, even check, 1 stop bit; 3: 8-bit data, odd check, 1 stop bit; 4: 8-bit data, no check,1 stop bit:	0-11	4	--

			5: 8-bit data, no check, 2 stop bits;																					
0x01C3	Pr5.25	RS485 control word		0-32767	0	--																		
0x01C4	Pr5.26	Communication bit delay		0-100	35	bit																		
0x01E1	Pr6.00	JOG velocity	This JOG is triggered by RS485. For JOG triggered by IO, please use Pr8.40/8.41	0-5000	60	r/min																		
0x01E3	Pr6.01	Interval		0-10000	100	ms																		
0x01E5	Pr6.02	Running times		0-30000	1	--																		
0x01E7	Pr6.03	Acc. / Dec. time		0-10000	200	--																		
0x01FF	Pr6.15	Version information	Read only	0-65535	0	--																		
0x0201	Pr6.16	Firmware information	Read only	0-65535	0	--																		
0x0231	Pr7.00	Motor model	Invalid	0-100	0	--																		
0x0233	Pr7.01	Encoder resolution	Encoder resolution of closed-loop stepper motor	0-20000	4000	CPR=4 *PPR																		
0x0235	Pr7.02	Back EMF coefficient	Invalid	0-32767	100	1ms																		
0x0237	Pr7.03	Current loop proportional KP	Invalid	0-3000	1500	--																		
0x0239	Pr7.04	Current loop KI	It is recommended to keep the factory value, when disable auto-tuning, can be modified	0-1500	300	--																		
0x023B	Pr7.05	Current loop KP		0-1024	100	--																		
0x023D	Pr7.06	Current loop Kc	Invalid	0-32767	300	--																		
0x0243	Pr7.09	Over-voltage threshold	Invalid	0-1000	90	V																		
0x1003	-	Motion status	Read only: <table border="1"> <thead> <tr> <th>Bit NO.</th> <th>Read value =1 means</th> </tr> </thead> <tbody> <tr> <td>Bit0</td> <td>Fault</td> </tr> <tr> <td>Bit1</td> <td>Enable</td> </tr> <tr> <td>Bit2</td> <td>Running</td> </tr> <tr> <td>Bit4</td> <td>Command completed</td> </tr> <tr> <td>Bit5</td> <td>Path completed</td> </tr> <tr> <td>Bit6</td> <td>Homing completed</td> </tr> </tbody> </table>	Bit NO.	Read value =1 means	Bit0	Fault	Bit1	Enable	Bit2	Running	Bit4	Command completed	Bit5	Path completed	Bit6	Homing completed		-	--				
Bit NO.	Read value =1 means																							
Bit0	Fault																							
Bit1	Enable																							
Bit2	Running																							
Bit4	Command completed																							
Bit5	Path completed																							
Bit6	Homing completed																							
0x1801	-	Control word	<table border="1"> <thead> <tr> <th>Write value</th> <th>Function</th> </tr> </thead> <tbody> <tr> <td>0x1111</td> <td>Reset current alarm</td> </tr> <tr> <td>0x1122</td> <td>Reset history alarm</td> </tr> <tr> <td>0x2211</td> <td>Save all parameters to EEPROM</td> </tr> <tr> <td>0x2222</td> <td>Parameter reset(exclude motor parameters)</td> </tr> <tr> <td>0x2233</td> <td>All parameters are reset to factory</td> </tr> <tr> <td>0x2244</td> <td>Save all mappings into EEPROM</td> </tr> <tr> <td>0x4001</td> <td>JOG CW (Need to write once at least 50ms)</td> </tr> <tr> <td>0x4002</td> <td>JOG CCW (Need to write once at least 50ms)</td> </tr> </tbody> </table>	Write value	Function	0x1111	Reset current alarm	0x1122	Reset history alarm	0x2211	Save all parameters to EEPROM	0x2222	Parameter reset(exclude motor parameters)	0x2233	All parameters are reset to factory	0x2244	Save all mappings into EEPROM	0x4001	JOG CW (Need to write once at least 50ms)	0x4002	JOG CCW (Need to write once at least 50ms)		-	--
Write value	Function																							
0x1111	Reset current alarm																							
0x1122	Reset history alarm																							
0x2211	Save all parameters to EEPROM																							
0x2222	Parameter reset(exclude motor parameters)																							
0x2233	All parameters are reset to factory																							
0x2244	Save all mappings into EEPROM																							
0x4001	JOG CW (Need to write once at least 50ms)																							
0x4002	JOG CCW (Need to write once at least 50ms)																							
0x1901	-	Save parameter status word	Read only <table border="1"> <thead> <tr> <th>Read Value</th> <th>Means</th> </tr> </thead> <tbody> <tr> <td>0x5555</td> <td>Save successfully</td> </tr> <tr> <td>0xAAAA</td> <td>Failed to save</td> </tr> </tbody> </table>	Read Value	Means	0x5555	Save successfully	0xAAAA	Failed to save		-	--												
Read Value	Means																							
0x5555	Save successfully																							
0xAAAA	Failed to save																							
0x2203	-	Current alarm	Read only <table border="1"> <thead> <tr> <th>Error code</th> <th>Means</th> </tr> </thead> <tbody> <tr> <td>0x01</td> <td>Over- current</td> </tr> <tr> <td>0x02</td> <td>Over- voltage</td> </tr> <tr> <td>0x40</td> <td>Current sampling fault</td> </tr> <tr> <td>0x80</td> <td>Failed to lock shaft</td> </tr> <tr> <td>0x200</td> <td>EEPROM fault</td> </tr> <tr> <td>0x100</td> <td>Auto-tuning fault</td> </tr> </tbody> </table>	Error code	Means	0x01	Over- current	0x02	Over- voltage	0x40	Current sampling fault	0x80	Failed to lock shaft	0x200	EEPROM fault	0x100	Auto-tuning fault		-	--				
Error code	Means																							
0x01	Over- current																							
0x02	Over- voltage																							
0x40	Current sampling fault																							
0x80	Failed to lock shaft																							
0x200	EEPROM fault																							
0x100	Auto-tuning fault																							

4.3.2 Input and Output Parameters

Register Address	Par. # in software	Definition	Description	Range	Default	Unit
0x0145	Pr4.02	SI1 (DI1)	(1) SI1 is set to enable by default, N.C (normally closed). (2) Other inputs are N.O (normally open) by default. (3) The value of bit7 of each input register is set normally closed or normally open, bit7=1 is normally closed, bit7=0 is normally closed	0-65535	136 (0x88)	--
0x0147	Pr4.03	SI2 (DI2)		0-65535	0	--
0x0149	Pr4.04	SI3 (DI3)		0-65535	0	--
0x014B	Pr4.05	SI4 (DI4)		0-65535	0	--
0x014D	Pr4.06	SI5 (DI5)		0-65535	0	--
0x014F	Pr4.07	SI6 (DI6)		0-65535	0	--
0x0151	Pr4.08	SI7 (DI7)		0-65535	0	--
0x0157	Pr4.11	SO1 (DO1)	(1) All outputs are N.O (normally open) by default, (2) The value of bit7 of each input register is set normally closed or normally open, bit7=1 is normally closed, bit7=0 is normally closed.	0-65535	0	--
0x0159	Pr4.12	SO2 (DO2)		0-65535	0	--
0x015B	Pr4.13	SO3 (DO3)		0-65535	0	--

Note: (1) If the input or output function is set repeatedly, only after the restart drive can detect it.

(2) When input functions are configured, it is effective after clicking save and restart drive.

Digital Input port function assignment:

Normal-open (N.O); Normal-closed (N.C).

Digital Inputs				Digital Outputs			
Functions	Symbols	Type		Functions	Symbols	Type	
		N.O.	N.C.			N.O.	N.C.
Trigger Command	CTRG	0x20	0xA0	Command Complete	CMD_OK	0x20	0xA0
Homing Trigger	HOME	0x21	0xA1	Path Complete	MC_OK	0x21	0xA1
Quick Stop	STP	0x22	0xA2	Homing Complete	HOME_OK	0x22	0xA2
JOG+	JOG+	0x23	0xA3	Alarm	ALM	0x25	0xA5
JOG-	JOG-	0x24	0xA4	Brake	BRK	0x24	0xA4
Positive Limit	PL	0x25	0xA5	In-position	PEND	0x23	0xA3
Negative Limit	NL	0x26	0xA6				
Home switch	ORG	0x27	0xA7				
Path Address 0	ADD0	0x28	0xA8				
Path Address 1	ADD1	0x29	0xA9				
Path Address 2	ADD2	0x2A	0xAA				
Path Address 3	ADD3	0x2B	0xAB				
Clear Error	CLR	0x07	0x87				
Enable	SRV-ON	0x08	0x88				

4.3.3 Smooth Filter Time Setting for Digital Inputs

This section describes the setting of the value of each bit of the registers of the 7 inputs, where the filtering time is set by the high 8 bits.

Set value of low 8 bits:

Normally open. Normally closed setting	Digital input function setting						
Bit7	Bit6	Bit5	Bit4	Bit3	Bit2	Bit1	Bit0
0: Normally open 1: Normally closed	(000 0000) 0x00: Invalid input. (000 1000) 0x08: Enable. (010 0000) 0x20: CTRG. (010 0001) 0x21: Homing trigger. (010 0010) 0x22: Quick stop. (010 0011) 0x23: JOG+. (010 0100) 0x24: JOG-. (010 0101) 0x25: Positive limit. (010 0110) 0x26: Negative limit. (010 0111) 0x27: Home switch. (010 1000) 0x28: Path address 0. (010 1001) 0x29: Path address 1. (010 1010) 0x2A: Path address 2. (010 1011) 0x2B: Path address 3. (010 1100) 0x2C: JOG2 velocity						

Set value of high 8 bits:

Reserved				Filter time setting																																					
Bit15	Bit14	Bit13	Bit12	Bit11	Bit10	Bit9	Bit8																																		
Reserved bit, write 0 by default				<table border="1"> <thead> <tr> <th>Register Value</th> <th>Filtering time (unit: ms)</th> </tr> </thead> <tbody> <tr><td>0000</td><td>10</td></tr> <tr><td>0001</td><td>1</td></tr> <tr><td>0010</td><td>2</td></tr> <tr><td>0011</td><td>3</td></tr> <tr><td>0100</td><td>4</td></tr> <tr><td>0101</td><td>5</td></tr> <tr><td>0110</td><td>6</td></tr> <tr><td>0111</td><td>8</td></tr> <tr><td>1000</td><td>15</td></tr> <tr><td>1001</td><td>20</td></tr> <tr><td>1010</td><td>30</td></tr> <tr><td>1011</td><td>40</td></tr> <tr><td>1100</td><td>50</td></tr> <tr><td>1101</td><td>100</td></tr> <tr><td>1110</td><td>200</td></tr> <tr><td>1111</td><td>500</td></tr> </tbody> </table>		Register Value	Filtering time (unit: ms)	0000	10	0001	1	0010	2	0011	3	0100	4	0101	5	0110	6	0111	8	1000	15	1001	20	1010	30	1011	40	1100	50	1101	100	1110	200	1111	500		
				Register Value	Filtering time (unit: ms)																																				
				0000	10																																				
				0001	1																																				
				0010	2																																				
				0011	3																																				
				0100	4																																				
				0101	5																																				
				0110	6																																				
				0111	8																																				
				1000	15																																				
				1001	20																																				
				1010	30																																				
				1011	40																																				
				1100	50																																				
1101	100																																								
1110	200																																								
1111	500																																								
<p>Note:</p> <p>(1) The values of the registers correspond to the individual filter times. The default state is 0000, which correspond to 10ms</p> <p>(2) If you need to set other filter times for the IO port, you can fill in the value manually in the parameter manage table of STEPPERONLINE MotionStudio.</p>																																									

Example 1: IO input port 1 is set to enable function. Normally closed. Filter time 50ms
 The register value is configured as 0000 1100 1000 1000, which is converted to 3208 in decimal, i.e. write 3208 to

Pr4.02 to achieve the above configuration.

Example 2: IO input port 1 is set to enable function. Normally closed. Filter time 10ms (default)
The register value is configured as 0000 0000 1000 1000, which translates to 136 in decimal, i.e. write 136 to Pr4.02 to achieve the above configuration.

Routine 3: IO input port 7 is set to JOG2 function. Normally open. Filter time 500ms
The register configuration is 0000 1111 0010 1100, which is converted to 3884 in decimal, i.e. write 3884 to Pr4.08 to achieve the above configuration.

4.3.4 Status Monitoring Parameters

Register address	Definition	Attributes	Unit	Description
0x1001	Control Mode	R	/	Invalid, always "0"
0x1003	Motion state	R	/	Bit0: 0--normally, 1--faulty; Bit1: 0--drive disable, 1--enable; Bit2: 0--not running, 1--running; Bit4: 0-- Command not completed, 1-- Command completed; Bit5: 0-- Path not completed, 1-- Path completed; Bit6: 0--Homing not completed, 1--Homing completed.
0x1010 (high 16-bit) 0x1011 (low 16-bit)	Position following error	R	pulses	-
0x1012 (high 16-bit) 0x1013 (low 16-bit)	Profile position	R	pulses	-
0x1014 (high 16-bit) 0x1015 (low 16-bit)	Feedback position	R	pulses	-
0x1044 (high 16-bit) 0x1045 (low 16-bit)	Profile velocity	R	rpm	-
0x1046 (high 16-bit) 0x1047 (low 16-bit)	Feedback velocity	R	rpm	-

4.3.5 Control Word and Status Word

- (1) The related function is started by sending the control word,
- (2) The completion is judged by checking the status word. The status word is automatically returned to its initial state after it is read.

■ Control Word

Register address	Definition	Attributes	Description
0x1801	Control word	W/S	Write 0x1111: Reset current alarm Write 0x1122: Reset history alarm Write 0x2211: Save all parameters to EEPROM Write 0x2222: Parameter reset (exclude motor parameters) Write 0x2233: All parameters are reset to factory Write 0x2244: Save all mapping parameters into EEPROM Write 0x4001: JOG CW (Need to write once at least 50ms) Write 0x4002: JOG CCW

■ Status Word of Saving Parameter

Register address	Definition	Attributes	Description
------------------	------------	------------	-------------

0x1901	status word	R	Show 0x5555: Saving parameter OK Show 0xAAAA: Saving parameter fault
--------	-------------	---	---

Note: (1) The read value is 0x1111 when no save instruction has been executed after the first power-up;
(2) The first read value is 0x5555 after a save instruction is executed, and then it changes back to 0x1111.

4.4 Error Codes and Troubleshooting

4.4.1 Communication Error Codes

When the master station receives a message from the slave about a communication error, you can follow the table below for analysis

No.	Return Commands (slave->master)		
	Symbols	Description	Content
1	ID	Slave ID	0-31
2	FC	Function code	FC+0x80
3	EC	Error Code	-
4	CRC	check code	Low
			High

■ Error Code

Error Code (EC)	Description
0x01	Wrong FC (This supports FC beside of 03h/ 06h/ 10h)
0x02	Wrong access address
0x03	Wrong data, for example, write data over-limit value, etc.
0x08	Wrong CRC check code

Example F: CRC check code error

Master-> slave data:

Message	01	03	00 01	00 01	D5 C1
Description	Slave ID	Function code	Register address	Read Number of registers	CRC check code

slave-> Master data:

Message	01	83	08	40 F6
Description	Slave ID	FC+0x80	Error code	CRC

Example F: Function code error

Master-> slave data:

Message	01	02	00 01	00 01	E8 0A
Description	Slave ID	Function code	Register address	Read Number of registers	CRC check code

slave-> Master data:

Message	01	82	01	81 60
---------	----	----	----	-------



Description	Slave ID	Function code + 0x80	Error code	CRC check code
-------------	----------	----------------------	------------	----------------

4.4.2 Drive Alarm Codes and Troubleshooting

Register Address	definition	operation	unit	description
0x2203	Current alarm	R	/	Below table

Error code and cause:

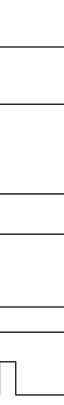
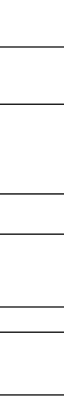
The green light is always on after the drive power on. When the error is occurred, the drive will stop working and red light will be flashed indicates the current error code. Whatever error occurs, the user need to power off the drive and restart it after removing the error. The user can read the corresponding error code through the PC software. The latest errors will be saved to EEPROM which supports 10 historical errors in the list.

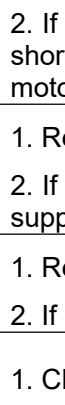
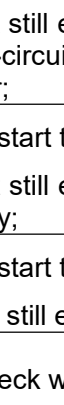
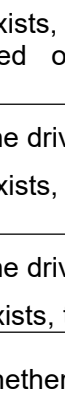
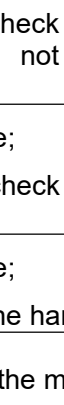
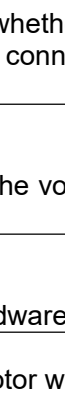
Error code	Content	Red Light Flash Times	Sequence wave of RED LED	Trouble Shooting
0x01	Over current	1		<ol style="list-style-type: none"> 1. Restart the drive; 2. If it still exists, check whether the motor is short-circuited or not connected to the motor;
0x02	Over voltage	2		<ol style="list-style-type: none"> 1. Restart the drive; 2. If it still exists, check the voltage of power supply;
0x40	Current sampling circuit error	3		<ol style="list-style-type: none"> 1. Restart the drive; 2. If it still exists, the hardware failure
0x80	Shaft locking error	4		<ol style="list-style-type: none"> 1. Check whether the motor wire is broken
0x200	EEPROM error	5		<ol style="list-style-type: none"> 1. Connect the drive to STEPPERONLINE software to reset parameters to the factory 2. If it still exists, the hardware failure
0x100	Auto tuning error	6		<ol style="list-style-type: none"> 1. Restart the drive; 2. If it still exists, disable auto-tuning by 0x01AB (Pr5.13).
0x20	Position following error	7		<ol style="list-style-type: none"> 1. Check if the value of encoder resolution 0x0233 (Pr7.01) is correct; 2. Check if the encoder cable is broken; 3. Check if the limit switch is damaged; 4. Check if the acceleration time is too small, or the starting speed is too large
-	Encoder cable error	8		<ol style="list-style-type: none"> 1. Check if the encoder cable is damaged; 2. Whether no encoder extension cable is used;
-	Repeated settings of input function	9		<ol style="list-style-type: none"> 1. Check input function settings

4.4.3 Error Clear

Check the error via STEPPERONLINE MotionStudio

Current Error	Current happened error	Over current, over voltage, etc
History error	History happened error .	Over current,over voltage,etc
Read error	Read Historical error .	Check the Historical happened error .
Clear current error	Current error	(1) It can clear over voltage error, but can not clear over current error; (2) There are two methods to clear the current alarm: one is via STEPPERONLINE MotionStudio, and the second is via external I/O, refer to Section 4.3.2. (3) If the current error cannot be cleared, please check the drive
Clear history error	History error	All history error records can be cleared by STEPPERONLINE MotionStudio

4.5 Register Mapping Continuous Read/Write Function

Address description 0x0F10-0x0F19. By writing the "address to be mapped" to 0x0F10-0x0F19, it is possible to set the address mapping. The 10 consecutive mapped addresses are available for mapping discontinuous parameter addresses.

Examples

Mapping target address	Write to	Parameter original address
0x0F10	←	0x0001 (Pr0.00: Microstep)
0x0F11	←	0x0009 (Pr0.04: inductance value)
0x0F12	←	0x00A1 (Pr2.00: instruction filter time)
0x0F13	←	0x0191 (Pr5.00: peak current)
0x0F14	←	0x0167 (Pr4.19: delay of releasing brake)
0x0F15	←	0x0173 (Pr4.25: software de-jitter delay of position when in position)
0x0F16	←	0x0233 (Pr7.01: encoder resolution)
0x0F17	←	0x0243 (Pr7.09: over-voltage threshold)
0x0F18	←	0x602E (Pr8.46: digital inputs)
0x0F19	←	0x6203 (Pr9.03: PR0 velocity)

At this point, the mapping of the 10 parameter addresses to the mapped area is complete, and the mapped addresses can be used for reading and writing instead of the original parameter addresses. For example, if 0x0001 is written to 0x0F10, the operation of reading and writing to 0x0001 can be replaced by "read and write to 0x0F10". The mapped address is equivalent to a "stand-in" or "proxy" for the original address.

Mapping target address	Reading and writing	Host
0x0F10 (Pr0.00: Microstep)	←----→	Host
0x0F11 (Pr0.04: inductance value)	←----→	
0x0F12 (Pr2.00: instruction filter time)	←----→	
0x0F13 (Pr5.00: peak current)	←----→	
0x0F14 (Pr4.19: delay of releasing brake)	←----→	

0x0F15 (Pr4.25: software de-jitter delay of position when in position)	←-----→	
0x0F16 (Pr7.01: encoder resolution)	←-----→	
0x0F17 (Pr7.09: over-voltage threshold)	←-----→	
0x0F18 (Pr8.46: digital inputs)	←-----→	
0x0F19 (Pr9.03: PR0 velocity)	←-----→	

Message Example

Conditions: Drive ID is 1, motor is stationary.

(1) Mapping

Master→Slave:

01 10 0F 10 00 0A 00 00 01 00 09 00 A1 01 91 01 67 01 73 02 33 02 43 60 2E 62 03 4B 43

Slave → Master:

01 10 0F 10 00 0A 42 DF

(2) Read and write

Master→Slave:

01 03 0F 00 00 0A C6 D9

Slave → Master:

01 03 14 27 10 05 87 00 0F 00 3C 00 FA 00 03 0F A0 00 5A 00 01 00 00 00 56 F4

(3) Mapping parameter save instruction 0x2244

Master→Slave:

01 06 18 01 22 44 C6 39 (Note: Write 0x2244 to 0x1801, the function is to save the mapped address into EEPROM)

Slave → Master:

01 06 18 01 22 44 C6 39

4.6 S-code Application

S-code (status code) is the status indicator of the currently executed PR path, whether it is running, or the path is completed.

In a normal path program, no matter which path is completed, the drive will output the run status uniformly, but it is difficult to identify which path. The S-code function can help to identify the specific path number and running status, or read the value of Pr8.38(0x601C). Each PR path can set an S-code, i.e. each path has a dedicated S-code register, the exact S-code is user-defined according to the table format below.

Size S	High 8 bits		Lower 8 bits	
# Bit	bit15	bit8-10	bit7	bit0-2
Description	Whether the S code is valid at the time of completion: 0: Invalid, keep last value 1: Effective (Recommended)	S-code at completion	Whether the start S code is valid or not: 0: Invalid 1: Effective (Recommended)	S-code at start-up
	bit7 and bit15 are set to 1. The rest of the unused bits are 0, such as bits 11-14, bits 3-6.			

CLRS series drivers have only 3 outputs, and the S-code can only use 3 bits, each bit corresponds to an output. Therefore, there are only 8 output combinations (000, 001, 010, 011, 100, 101, 110, 111), and these 8 states can be set freely, depending on the requirements.

Example:

Here is an example of paths 1-4:

- All output ports are set to normally open.
- “1” indicates that the output optocoupler is switched on.
- “0” indicates that the output optocoupler is switched off.
- “001” means that output port 1 is on, and outputs 2 and 3 are not on.
- Pr8.28: S-code current output value; register address: 0x601C.

Path	S-code at	S-code at	S code setting value	Remarks
------	-----------	-----------	----------------------	---------

number	completion bit8-10	start-up bit0-2		
Path 1	001	000	Binary: 1000 0001 1000 0000 Hexadecimal: 0x8180	At start-up: No level at all three outputs Completion: Output port 1 has level, PR8.28=1
Path 2	011	010	Binary: 1000 0011 1000 0010 Hexadecimal: 0x8382	At start-up: Output port 2 has level On completion: Outputs 1 and 2 have levels, PR8.28 = 3
Path 3	101	100	Binary: 1000 0101 1000 0100 Hexadecimal: 0x8584	At start-up: Output port 3 has level On completion: Outputs 1 and 3 have levels, PR8.28 = 5
Path 4	111	110	Binary: 1000 0111 1000 0110 Hexadecimal: 0x8786	At start-up: Outputs 2 and 3 are level When finished: output ports 1. 2. 3 are level, PR8.28=7

4.7 Enable Drive

There are two methods to enable CLRS series drives:

- I/O enable:
DI1 of CLRS series drive is the enable input by default, normally closed, so CLRS drive immediately enters the enable state after power on.
- RS485 communication:
Pr0.07 of STEPPERONLINE MotionStudio (Register address 0x00F) set to value “1” indicates enable the drive by RS485

5 PR Mode (Indexer Table)

PR mode is a single-axis motion control function with 16-segment position table, also called indexer table. It can save the motion control function of the controller.

5.1 PR Main Features

PR mode can mainly set the following functions:

Features	Description
Homing	<p>The drive can detect zero position by homing processing, and confirm the zero point of mechanical coordinate system</p> <ul style="list-style-type: none"> ● Select homing method: by limit switch signal, by home switch signal, auto homing after power up, set homing point by manual; ● Homing direction can be set; ● Homing offset can be set; ● Move to the specified position after homing; ● Acc/Dec of homing velocity can be set; <p>Note: Control instruction can not be sent to drive during homing</p>
JOG	<p>JOG can be realized by external I/O or RS485 communication.</p> <ul style="list-style-type: none"> ● CW JOG; ● CCW JOG; ● JOG teaching function; ● The JOG velocity and JOG Acc/Dec can be set;

Limit	<p>Protect the machine by limiting the working area range.</p> <ul style="list-style-type: none"> • Positive/negative limit switch by digital input; • Soft limit setting; • Acc/Dec limit can be set <p>Note: Soft limit is valid after homing completed;</p>
Quick stop	The movement stop immediately when the quick stop input is on, which is valid at PR mode only
PR Path	<p>Select the PR path number by 4 digital inputs (ADD0, ADD1, ADD2, ADD3), and then start the PR path movement by external I/O (CTRG) or RS485communication.</p> <ul style="list-style-type: none"> • Include PP mode, PV mode and HM mode • Trigger methods include: double edge trigger (CTGR) or RS485 trigger • Support up to 16-segment PR positioning path • Position, velocity and Acc/Dec values can be set • Pause time or timing time can be set • Support interrupt, Overlapping, jump, etc.
Path Trigger	The above PR functions can be controlled by RS485

5.2 Homing / Return to Zero Position

Homing includes homing by detecting limit switch signal, homing by detecting home switch signal, set zero position by manual, auto homing after powering on.

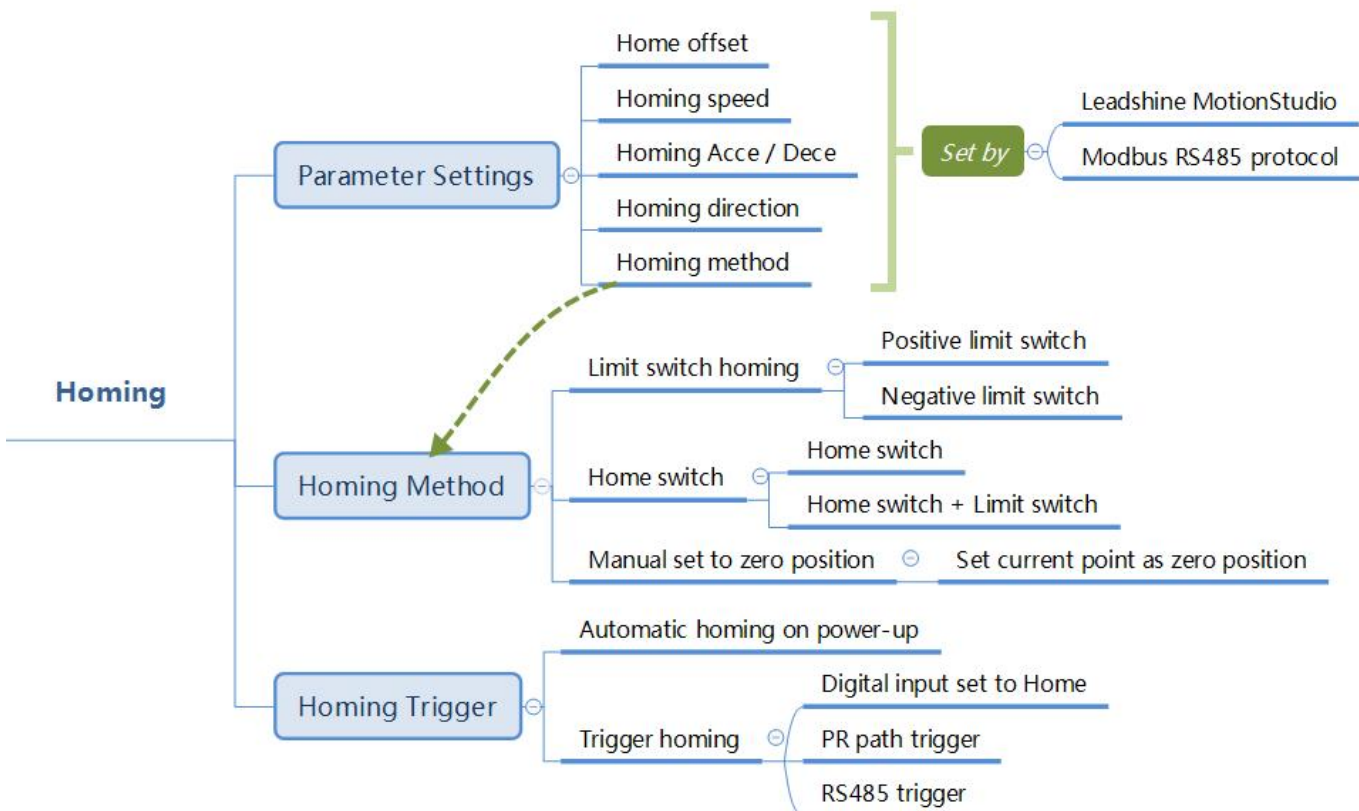

Zero Position: a fixed position on the machine can correspond to a definite digital input signal, or to a Z signal
 Zero Point of Machine: mechanical absolute zero position
 Home offset: difference between zero position and zero point of machine, the value of Object 607Ch (default = 0), Zero position= zero point + home offset

Home Switch: homing switch input signal
 Negative Limit: negative limit switch input signal
 Positive Limit: positive limit switch input signal

Trigger method of homing:

- Automatic homing on power-up: After the drive is powered on, the motor will automatically search the zero position.
- Trigger to homing: when IO port set to Home function triggered by external level, or trigger via Modbus RS485.

Homing method:

- Limit switch homing: Set by register address 0x600A, or STEPPERONLINE software. If the homing direction is positive, then it is positive limit switch homing. Conversely, the negative limit homing.
- Home switch: Set by register address 0x600A, or STEPPERONLINE software. If the motor turns toward the home switch when zeroing, it will use the home switch it touches as the home point; if the motor turns in the opposite direction when zeroing, it will automatically reverse to find the home point after it touches the limit switch.
- Manual set to zero position: Set by register address 0x600A, or by tuning software. After triggering, the current value of the motor is cleared to zero and the current point is used as the origin.

Note: In the normal homing, because the motor to find the origin process is slowed down and stopped, so after finding the origin will move a certain distance, the actual read position value may not be 0, in this case, you can check the "return to the origin to move to the specified position", that is, move to the 0 position.

5.2.1 Homing Parameters

Parameters	Register address	Definition	Description
Pr8.10	0x600A	Homing mode	Bit0: homing direction =0: CCW; =1: CW. Bit1: move to the Specified point after homing? =0: No; =1: Yes. Bit2- Bit3: homing method =00: Homing by detecting limit switch signal =01: Homing by detecting Home Switch signal =10: Homing by Z signal (index signal) Note: (1) Write 0x21 to the address 0x6002 to set the current point to zero position; (2) Write 1 to the bit2 of address 0x6000 can set to auto-homing after powering on;
Pr8.11	0x600B	Home Switch position high bits	The Home Switch position on the coordinate system. Pr8.11 is high 16 bits, and Pr8.12 is low 16 bits
Pr8.12	0x600C	Home Switch low bits	
Pr8.13	0x600D	Homing stop position high bits	The motor moves to the Specified position after homing. If bit1 of Pr8.10=1, the motor will move to Specified absolute position. Pr8.13 is high 16 bits , and Pr8.14 is low 16 bits.
Pr8.14	0x600E	Homing stop position low bits	
Pr8.15	0x600F	Homing high velocity	The 1 st segment velocity of homing, unit: rpm
Pr8.16	0x6010	Homing low velocity	The 2 nd segment velocity of homing, unit: rpm
Pr8.17	0x6011	Homing Acc	Acc of homing, unit: ms/1000rpm
Pr8.18	0x6012	Homing Dec	Dec of homing, unit: ms/1000rpm

Note: Generally homing to find the zero position, the motion is decelerating to stop, so after finding the zero position will also move a distance, resulting in the actual read position value may not be mechanical zero point, but will still output homing completion signal. If the motion is an absolute position mode, it does not matter. But if the user does care about the zero position, you can set the value of home offset to reach the mechanical zero point

5.2.2. Homing by Home Switch

Set value 1 to the bit2 of 0x600A, and then according to the homing direction, positive or negative limit switch and location of home switch, it can be combined into the following four cases.

(1) Home Switch & Positive Limit Switch

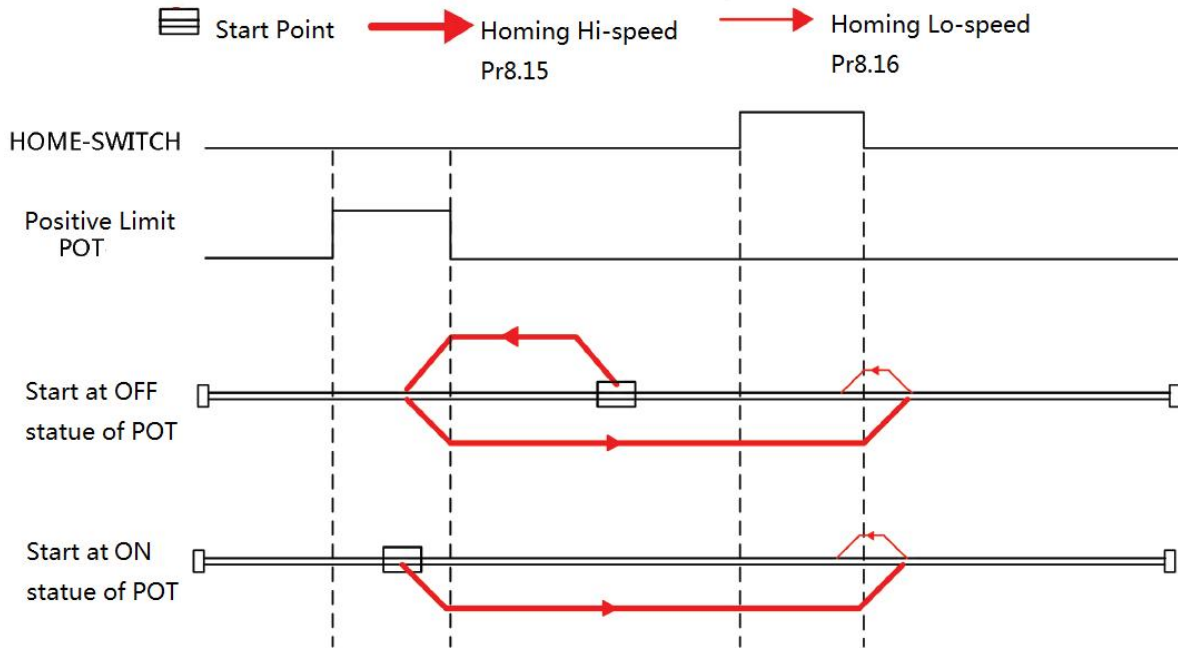

(2) Home Switch at Positive Direction

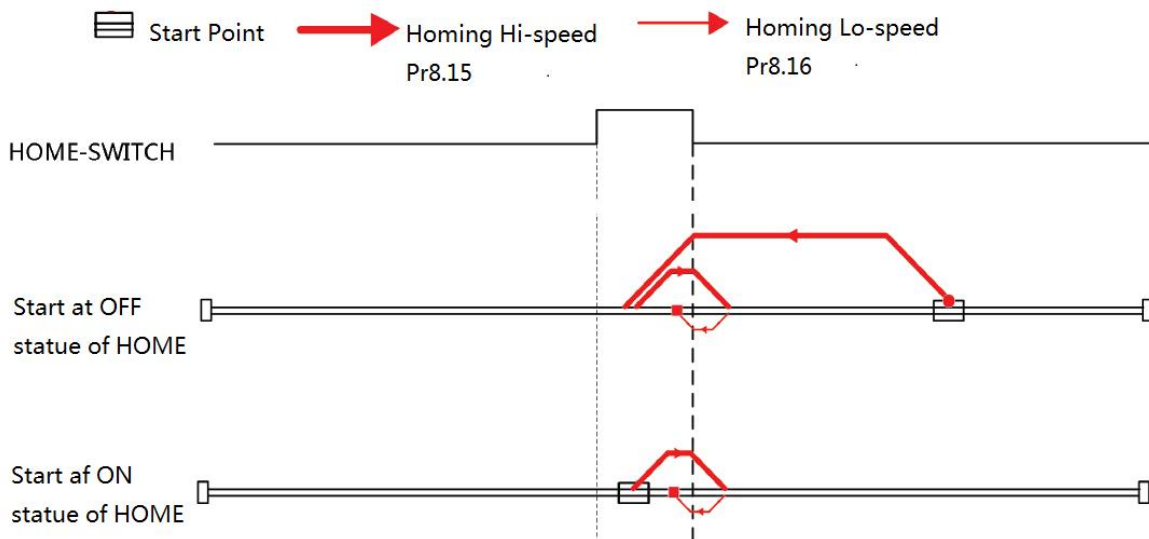

(3) Home Switch & Negative Limit Switch

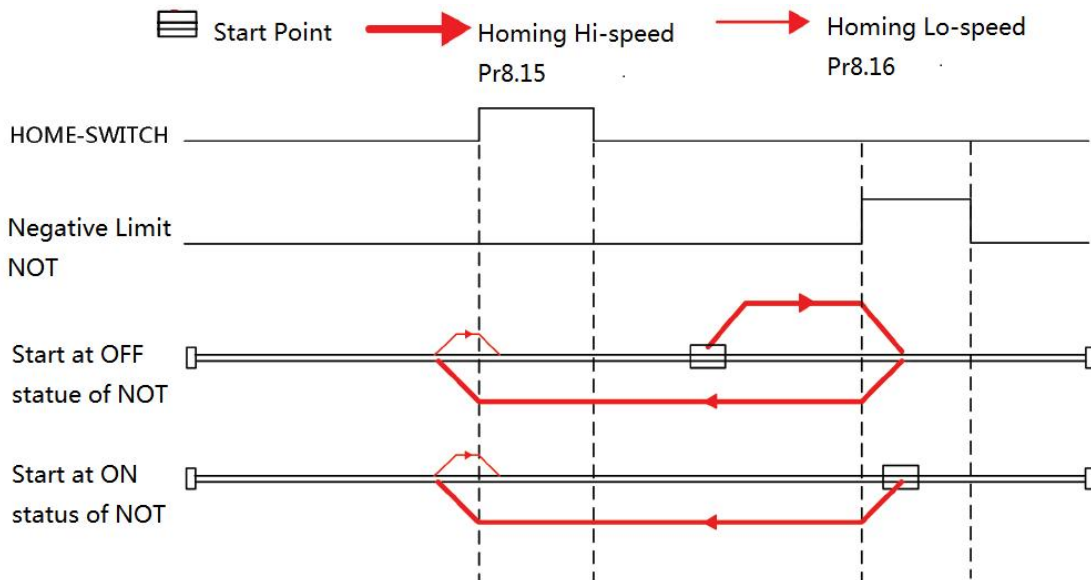

(4) Home Switch at Negative Direction

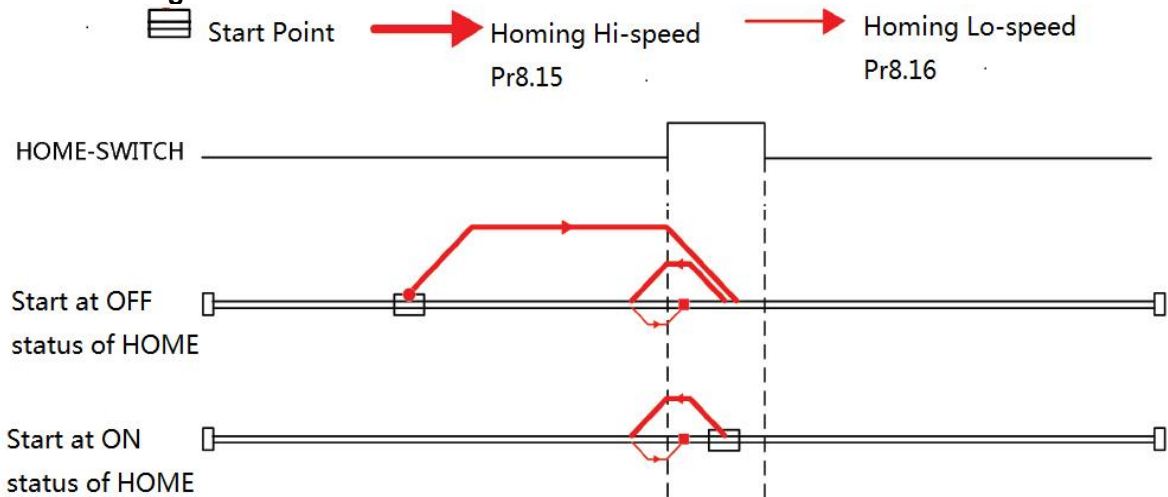

5.2.3. Homing by Limit Switch

(1) Positive Limit Switch

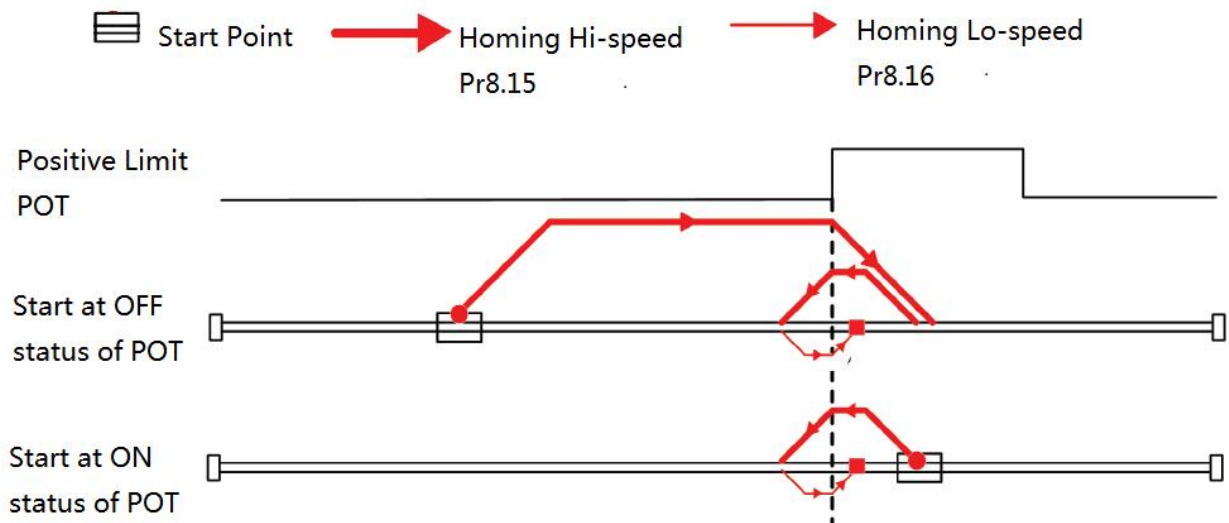

(2) Negative Limit Switch

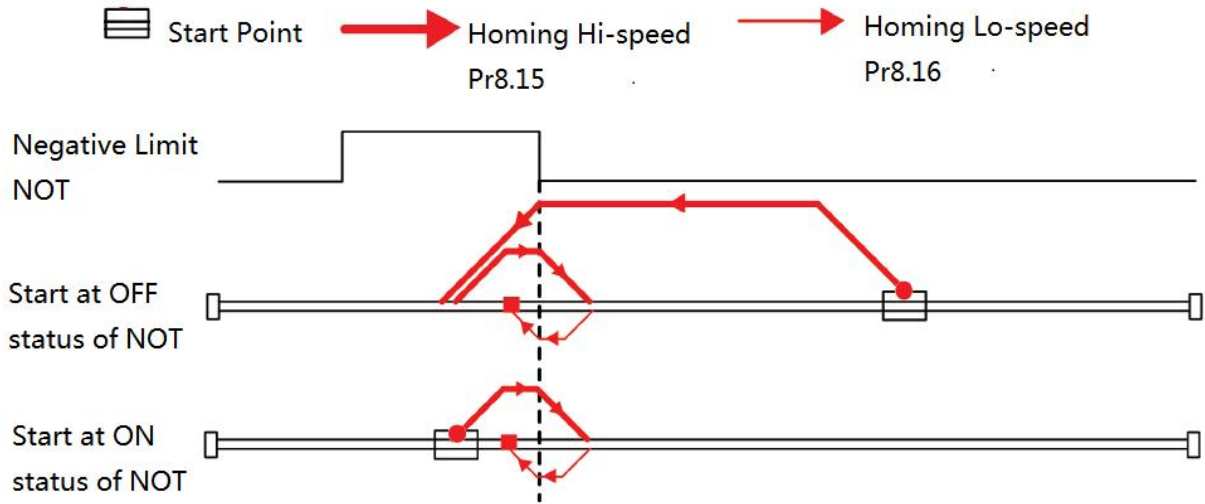

5.2.4. Torque zeroing

Torque zeroing, also known as stall zeroing, is a process in which a motor is driven to a stall condition and then held there for a fixed period of time. After this time period has elapsed, it is assumed that the torque acting on the motor has reached a steady state, and the current position of the motor is taken as the new zero point. The torque zero return mode can be selected on the MS debugging software, or by registering server address operation.

Pr8.19	0x6013	Torque zero return time	Torque retention time for torque zero return, unit ms
Pr8.20	0x6014	Torque zero return value	The force value of torque zero return mode, the step is the set current percentage, unit %

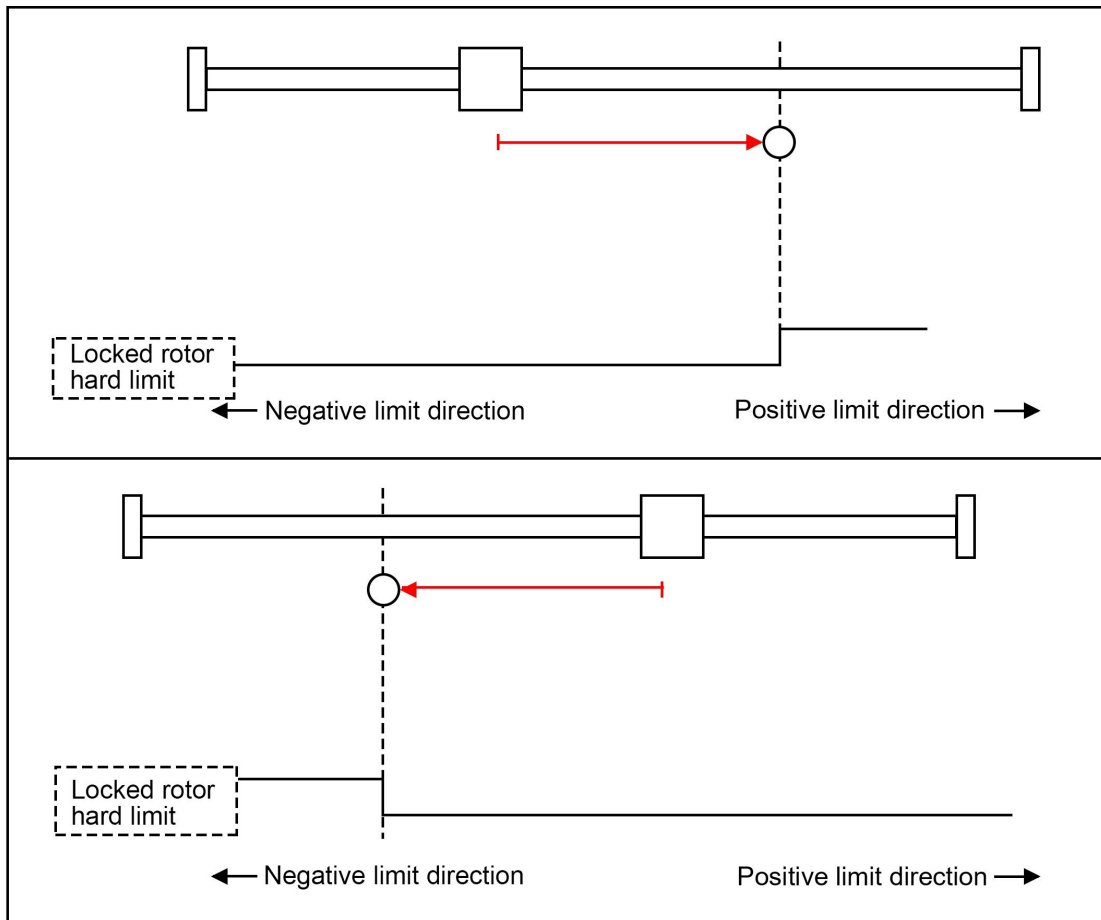

5.3 Soft Limit & JOG & Quick Stop

5.3.1 Soft Limit

The soft limit function means that the internal position feedback of the drive is compared with the limit position, an alarm and stop when determining that the motor exceeds the limit position. Soft limit function is universal for linear movement and rotating movement. It is not requiring hardware, eliminating malfunction due to poor wiring contact, and it can prevent mechanical slip and abnormal action with internal position comparison. And the CLRS series drives carry out homing to find the mechanical home before the soft limit function can be activated.

Relevant objects:

Register address	Par. # in software	Definition	Range	Default Value	Description
0x6000	Pr8.00	PR control setting	32767	-	Bit1: Soft limit.. 0--disable, 1--enable
0x6006	Pr8.06	Soft limit+ H	32767	0x7FFF	Soft limit positive high bits
0x6007	Pr8.07	Soft limit+ L	32767	0xFFFF	Soft limit positive low bits
0x6008	Pr8.08	Soft limit- H	32767	0x8000	Soft limit negative high bits
0x6009	Pr8.09	Soft limit- L	32767	0	Soft limit negative low bits
0x6016	Pr8.22	Soft limit quick stop time	-	-	Deceleration time after triggering the soft limit, unit: ms

5.3.2 JOG

The JOG function allows fine tuning of the drive, or fine adjustment of the position of the device, or forward and reverse velocity operation of the motor. Commonly used for velocity operation.

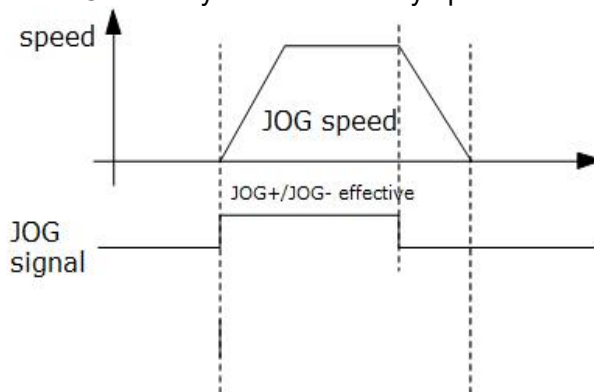

JOG time sequence

Relevant objects:

Register address	Par. # in software	Definition	Default Value	Description
0x6026	Pr8.38	JOG 2 velocity	0	JOG triggered by external I/O signal, Unit: rpm
0x6027	Pr8.39	JOG 1 velocity	0	
0x6028	Pr8.40	JOG Acceleration	0	Unit: ms/1000rpm
0x6029	Pr8.41	JOG Deceleration	0	Unit: ms/1000rpm
0x01E1	Pr6.00	JOG velocity	60	Unit: rpm
0x01E3	Pr6.01	Interval	100	Unit: ms
0x01E5	Pr6.02	Running times	1	Unit: ms/1000rpm
0x01E7	Pr6.03	Acc. / Dec. time	200	Unit: ms/1000rpm

Note:(1) Pr8.39 - Pr8.41(JOG) are available when triggered by I/O; (2) Pr6.00 - Pr6.03 (JOG) are available when triggered by RS485.

The trigger mode of JOG is divided into two types: RS485 communication and IO, which correspond to different parameter addresses:

RS485 communication trigger JOG:

- Write value 0x4001 to 0x1801, JOG+.
- Write value 0x4002 to 0x1801, JOG-.
- JOG velocity: Pr6.00 (0x01E1).
- JOG acceleration and deceleration time: Pr6.03 (0x01E7).
- JOG quick stop: write value 0x40 to 0x6002.

Note: JOG triggered by RS485 communication will run continuously only if the trigger interval is less than 50ms, otherwise it can only point operation.

IO trigger JOG:

- Assign JOG+ and JOG- to IO port. Then through input level to trigger JOG function.
- JOG velocity: Pr8.39 (0x6027).
- JOG acceleration time: Pr8.40 (0x6028).
- JOG deceleration time: Pr8.41(0x6029)
- JOG quick stop: write value 0x40 to 0x6002; or trigger forced quick stop input to IO port; or stop giving IO port level if using level trigger method.

Example for JOG+ /- and IO Trigger

CLRS uses JOG+/JOG- to achieve forward and reverse rotation operation; the running velocity can be set in JOG velocity and JOG velocity 2, then through the external IO signal to realize the two velocity switching. During the is running, the value of velocity can be modified and effect in real time. The path motion can also be triggered by external IO.

- SI1 is set to enable input by default, normally closed.
- SI2 is set to JOG+, used for positive directional velocity operation.
- SI3 is set to JOG-, used for negative directional velocity operation.
- SI6 is set to JOG velocity 2, used for JOG high and low velocity switching.
- SI4 is set to trigger signal CTRG, which is used to trigger path motion.
- SI5 is set to ADD0, used to select path number.

Note: the value of Pr8.38 is as JOG velocity 2, the value of Pr8.39 is as JOG velocity.

- When SI2 is switched on, the motor runs in the positive direction of JOG velocity.
- When SI3 is switched on, the motor runs in negative JOG velocity.
- When SI6 is switched on, the motor switches to JOG velocity 2 operation.
- If SI2and SI3are not switched on, the motor stops.
- When SI4 is switched on, start running on Path 0, [refer to Section 5.4.2](#)
- When SI5 is switched on, then SI4 on, and start running on Path 1, [refer to Section 5.4.2](#)

5.3.3 Quick Stop

The CLRS series drives have two types of quick stop: digital input quick stop signal and register quick stop.

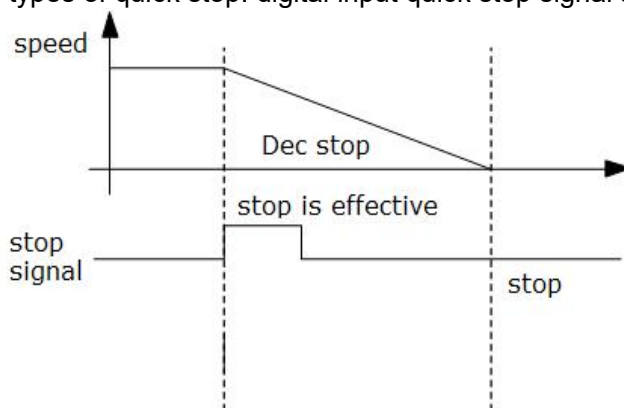

Quick stop time sequence

Relevant objects:

Register address	Par. # in software	Definition	Range	Default Value	Description
0x6017	Pr8.23	Quick stop time			Deceleration time after quick stop, unit: ms
0x6002	Pr8.02	Trigger register			Write value 0x040---- E-stop;

5.4 PR Path

The PR path can be run with single segment movement or continuous movement, which includes three operation modes: position mode, velocity mode and homing mode. There are 16 PR paths, and each path sets the operation modes, the target position, the target velocity, the acceleration and deceleration and the pause time, etc.

5.4.1 PR Parameters

Usually it is recommended using the PTP window of the STEPPERONLINE tuning software to configure the PR path parameters, but it can also use the following objects:

Par. # in software	Register Address	Definition	Description
Pr9.00	0x6200	PR path 0	The corresponding functions can be selected for different bit Bit0-3: Operation mode =0---- no action =1---- position mode =2---- velocity mode =3---- homing mode; Bit4: INS, =0---- No interrupt =1---- interrupt(all the current ones are 1.); Bit5: OVLP, =0---- Non overlapping =1---- Overlapping Bit6: =0----absolute position =1----relative position Bit8-13: Jump to the corresponding PR path 0-15; bit14: JUMP, =0---- No jump =1---- jump
Pr9.01	0x6201	Position H	High 16 bit,
Pr9.02	0x6202	Position L	Low 16 bit
Pr9.03	0x6203	velocity	Unit: rpm
Pr9.04	0x6204	Acc	Unit: ms/1000rpm
Pr9.05	0x6205	Dec	Unit: ms/1000rpm
Pr9.06	0x6206	Pause time	Pause time after the command is stopped
Pr9.07	0x6207	Special parameter	PR Path 0 maps directly to Pr8.02, Others are reserved
Pr9.08	0x6208	PR path 1	---
Pr9.09	0x6209	Position	---
Pr9.10	0x620A	Position	---
Pr9.11	0x620B	velocity	---
Pr9.12	0x620C	Acc	---
Pr9.13	0x620D	Dec	---
Pr9.14	0x620E	Pause time	---
Pr9.15	0x620F	Special parameter	---
Pr9.16	0x6210	PR path 2	---
Pr9.17	0x6211	Position	---
Pr9.18	0x6212	Position	---
Pr9.19	0x6213	velocity	---
Pr9.20	0x6214	Acc	---
Pr9.21	0x6215	Dec	---
Pr9.22	0x6216	Pause time	---

Pr9.23	0x6217	Special parameter	---
Pr9.24- Pr9.31	Similar as above paths	Similar as above paths	PR path 3
Pr9.32- Pr9.39	Similar as above paths	Similar as above paths	PR path 4
Pr9.40- Pr9.47	Similar as above paths	Similar as above paths	PR path 5
Pr9.48- Pr9.55	Similar as above paths	Similar as above paths	PR path 6
Pr9.56- Pr9.63	Similar as above paths	Similar as above paths	PR path 7
Pr9.64- Pr9.71	Similar as above paths	Similar as above paths	PR path 8

5.4.2 PR Path Configuration

If use the digital input ports to configure the PR path, they can be set to ADD0, ADD1, ADD2 and ADD3, thus forming 16-segment PR path, and then trigger the path number to complete the PR motion.

Each digital input of the drive can be configured as any one of ADD0 - ADD3, then combine the path numbers, as shown in the table below, "on" means the digital input is configured as ADDx (x=1-3), and the input signal optocoupler on, "off" means signal input off.

PR path	SI1 (ADD0)	SI2 (ADD1)	SI3 (ADD2)	SI4 (ADD3)	SI5 (CTRG)
Path 0	off	off	off	off	on
Path 1	on	off	off	off	on
Path 2	off	on	off	off	on
Path 3	on	on	off	off	on
Path 4	off	off	on	off	on
Path 5	on	off	on	off	on
Path 6	off	on	on	off	on
Path 7	on	on	on	off	on
Path 8	off	off	off	on	on
Path 9	on	off	off	on	on
Path 10	off	on	off	on	on
Path 11	on	on	off	on	on
Path 12	off	off	on	on	on
Path 13	on	off	on	on	on
Path 14	off	on	on	on	on
Path 15	on	on	on	on	on

Note: The 4 digital inputs do not have to be configured as ADD0 - ADD3, it is configured according to the actual required path motions. For example, if only Path0 is needed, refer to the above table, SI1-4 are not required to be configured as ADD0 - ADD3, because they are "off", only one input needs to be configured as CTRG.

5.4.3 Other functions of PR

● **Timing sequence of signal path**

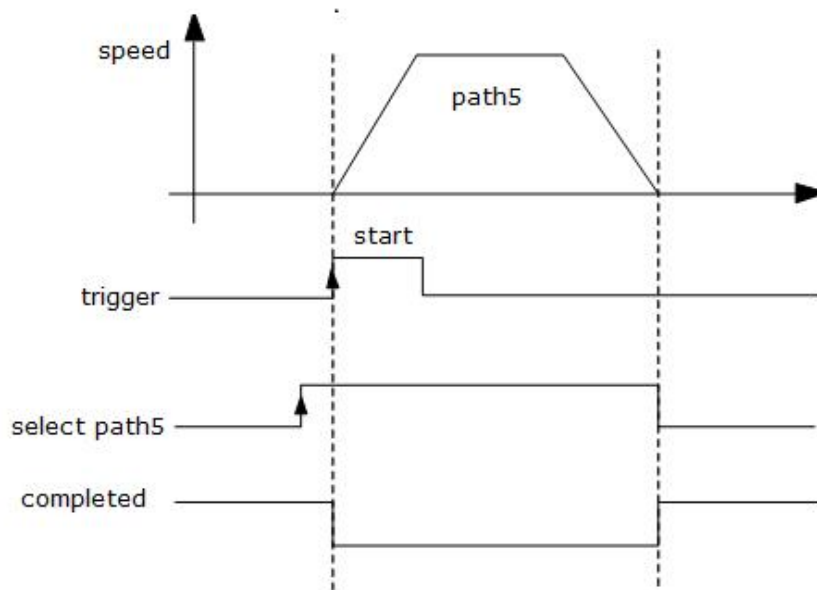

Single path sequence diagram

● **5.5.3 Multi-segment Jump**

For example: set paths 5 and 9, set path 5 to jump to path 9.

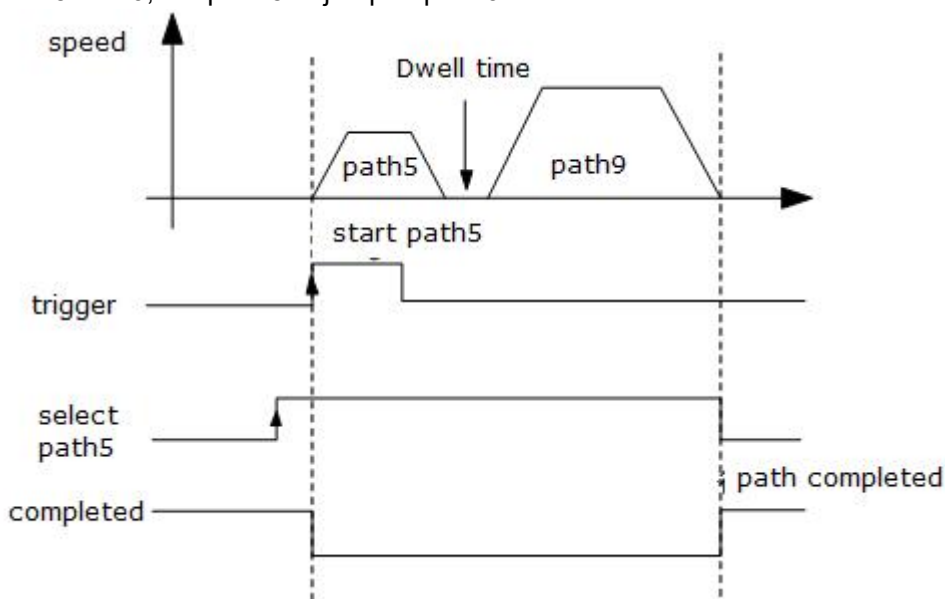

Multi-segment jump path sequence diagram

● **Continuous movement**

The bit5 of Pr9.00 is 0 , which does not overlap the continuous path.

As shown in the figure below, set PR1 (PR path1) and PR2 (PR path2) to run continuously and PR1 jump. There is no in-position signal in the intermediate delay from PR1 jump to PR2.

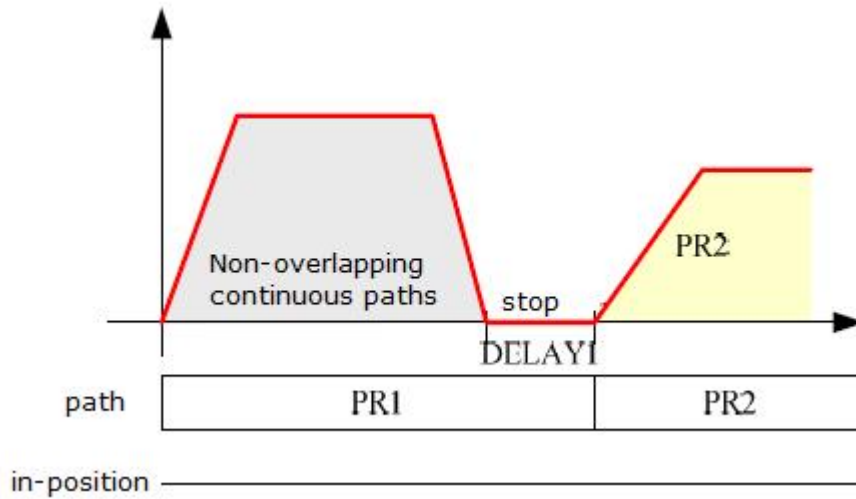

Continuous movement timing sequence (no overlap).

● **Interrupt function**

The interrupt function is the priority of a PR path. Interrupts a valid path means that interrupting and abandoning the current path under trigger, and runs another path directly, which is similar as Interrupt priority of function.. As below example, interrupt the PR1 (PR path1) to run PR2 (PR path2)

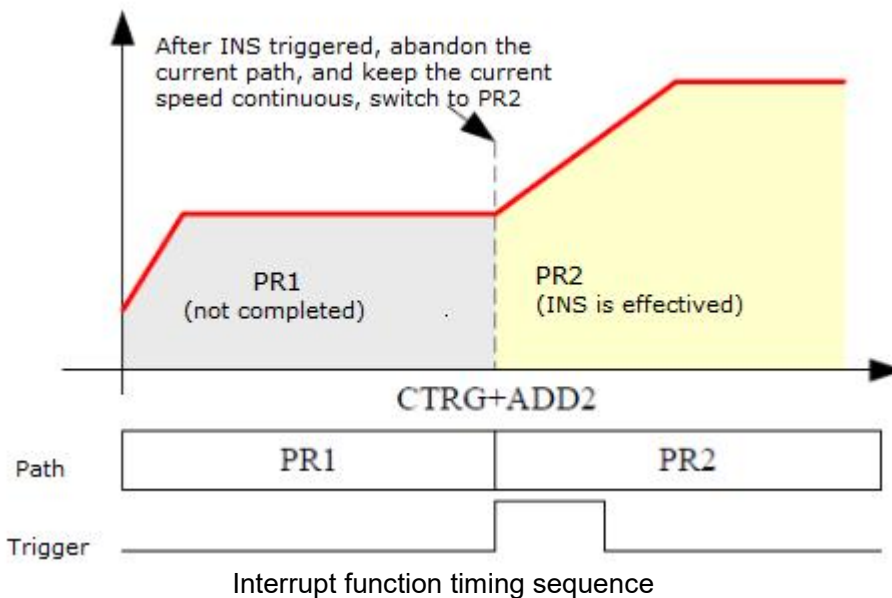

Interrupt function timing sequence

5.5 Trigger Methods

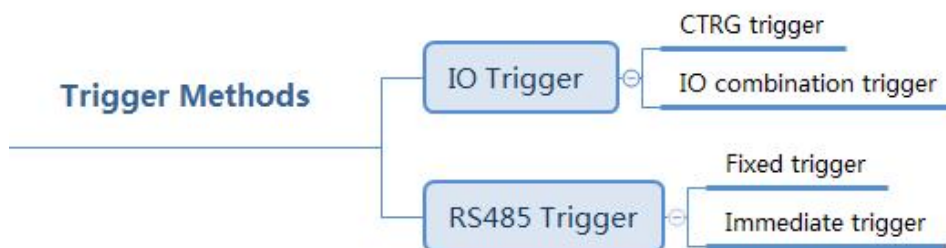

5.5.1 CTRG Trigger

When the path triggered by CTRG, it can be configured for rising edge triggering or double edge triggering. (No falling edge trigger function).

Par. #	Register address	Definition	Description
Pr8.00	0x6000	PR control setting	Global Control function of PR: Bit0: CTRG =0: Rising edge trigger =1: Double edge trigger; Bit1: =0: Soft limit is invalid =1: Soft limit is valid; Bit2: =0: homing after power up is invalid =1: homing after power up is valid;

For example: 4-segment PR path

The CTRG trigger method requires not only the configuration of the required number of paths, but also the setting of an additional input to the CTRG signal

- SI4 is set to enable input by default, normally closed.
- SI1 is set to ADD0, normally open,
- SI2 is set to ADD1, normally open,
- Set SI5 as trigger (CTRG).
- When CTRG is on, SI1 and SI2 are off, the path 0 is triggered;
- When CTRG and SI1 are on, and SI2 is off, the path 1 is triggered;
- When CTRG and SI2 are on, and SI1 is off, the path 2 is triggered;
- When CTRG, SI1 and SI2 are all on, the path 3 is triggered.

As shown in the table below, on means signal input on, off means signal input off

IO/running path	SI1 (ADD0)	SI2 (ADD1)	SI5 (CTRG)
Path 0	off	off	on
Path 1	on	off	on
Path 2	off	on	on
Path 3	on	on	on

5.5.2 IO Combination Trigger

The configuration is done by the parameter Pr8.26 Combination trigger mode. With the IO combination trigger, there is no need to set one digital input as the trigger signal (CTRG), which saves IO port and makes the control simpler. After programming the path number, the path can be triggered directly by ADD0-ADD3. **(In this mode, PR0 is not available.)** The parameter Pr8.26=2 enables this function.

Par. #	Register address	Definition	Description
Pr8.26	0x601A	IO combination trigger method	0: Turn off IO combination trigger 1: Enable IO combination trigger, return to zero OK to be effective 2: Enable IO combination trigger, no need to return to zero

For example: 3-Segment PR Path

Path configuration example:

- SI1 is set to enable input by default, normally closed.
- SI2 is set to ADD0, normally closed, means ADD0 is “on”.
- After triggering SI3, then SI2, SI3, SI4 are “on, on, off”, the path 3 is triggered.
- After triggering SI3 and SI4, then SI2, SI3, SI4 are “on, on, on”, the path 7 is triggered.

- If SI2 and SI3 are “off”, and only SI1 is “on”, the path 1 is triggered. If the velocity of path 1 is 0, i.e. the motor stops immediately.

Path number	SI2(ADD0)	SI3(ADD1)	SI4(ADD2)
Path 1	ON	OFF	OFF
Path 2	OFF	ON	OFF
Path 3	ON	ON	OFF
Path 4	OFF	OFF	ON
Path 5	ON	OFF	ON
Path 6	OFF	ON	ON
Path 7	ON	ON	ON

Note: “on” the input signal optocoupler on, “off” means signal optocoupler off.

5.5.3 Fixed Trigger

Fixed trigger mode is after configuring homing and path (less than 16-segment), then use Pr8.02(0x6002) to start the operation path which replace IO functions of CTRG and HOME. This method is suitable for systems with fixed and simple motion. (Recommended).

Steps as below:

1. Firstly, configure required homing and path, it can be set through controller/PLC software after power-on , or through STEPPERONLINE PC software;
2. Enable drive;
3. Write corresponding command to the 0x6002 to realize the selection and startup of each action.

Par. #	Register address	Definition	Description
Pr8.02	0x6002	Trigger register	<p>Write corresponding command to the 0x6002 to realize the selection and startup of each action.</p> <p>Write value 0x01P----P-segment positioning, (P indicates path #0-15);</p> <p>Write value 0x020---- Homing; (edge triggered)</p> <p>Write value 0x021---- Set the current position as origin by manual;</p> <p>Write value 0x040---- E-stop;</p> <p>Read value 0x000---- Positioning is completed and new data can be received;</p> <p>Read value 0x01P, 0x020, 0x040---- Not responding to the command;</p> <p>Read value 0x10P---- Path is running;</p> <p>Read value 0x200---- Command is completed and waiting for positioning.</p> <p>Note: (P indicates path NO. 0-15);</p>

5.5.4 Immediate Trigger

The immediate trigger method means that each time the current path 0(PR0) is written, the run of PR0 is triggered in real time. The position & velocity& homing and so on are achieved through one data frame. This method uses PR0 to implement, which has 8 data, the last parameter Pr9.07 is mapped to Pr8.02, writing value 0x10 to it will trigger PR0 motion immediately, thus realizing the immediate trigger operation.

Order		Sending message (Master->Slave)		Return message (Slave->Master)		
1	ID	Slave ID.	0-31	ID	Sub-station No.	0-31
2	FC	Function code	0x10	FC	Function code	0x10
3	ADDR	Address	0x62	ADDR	Address	0x62
4			0x00			0x00
5	NUM1	Number of Word	0x00	NUM	Actually written Number of	0x00
6			0x08			0x08
7	NUM2	Number of Byte	0x10	CRC	check code	Lo
8-9	Pr9.00	Mode	XXXX			Hi
10-11	Pr9.01	High position	XXXX			
12-13	Pr9.02	Low position	XXXX			
14-15	Pr9.03	velocity	XXXX			
16-17	Pr9.04	Acceleration	XXXX			
18-19	Pr9.05	Deceleration	XXXX			
20-21	Pr9.06	Delay time	XXXX			
22-23	Pr9.07	Trigger control	0x0010			
24	CRC	Check code	Lo			
25			Hi			

For example:

PR0: velocity 200 rpm, distance 10000 p

Master sending: 07 10 62 00 00 08 10 00 01 00 00 27 10 00 00 27 10 27 10 00 00 00 10 8D 50

Drive return: 07 10 62 00 00 08 DE 11

6 Tuning Operations

There are three kinds of tuning operations for CLRS series:

- (1) Through the trial run function of STEPPERONLINE's MotionStudio software,
- (2) Through the PR function of STEPPERONLINE's MotionStudio software,
- (3) Through the general serial port tool software.

6.1 Basic operation of STEPPERONLINE MotionStudio

This uses RS232 communication to control the motor, The STEPPERONLINE MotionStudio software currently available is version 1.3.10, which supports Windows 7 and Windows 10 systems.

6.1.1 Preparation and Steps

(1) RS232 Tuning cable

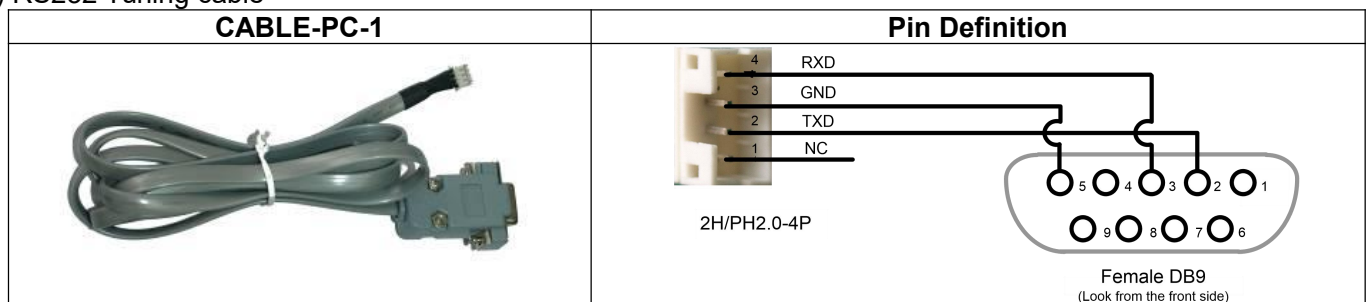

It is recommended that users order this cable directly from STEPPERONLINE, not to make it yourself

(2) USB to RS232 converter, sometimes it needs to manually install the drive program.

(3) COM port selection, as shown in the figure below, the communication port is COM3:

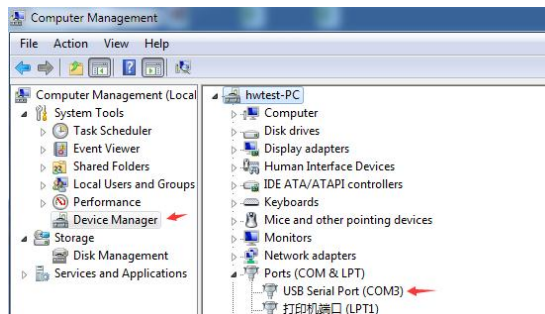

(4) Connect tuning software

Select COM3, do not select baud rate and device number, keep the default settings. After clicking connect, it will display the driver model. The number of ports and other information, and the lower left corner of the color block turns green, indicating that the connection has been successful.

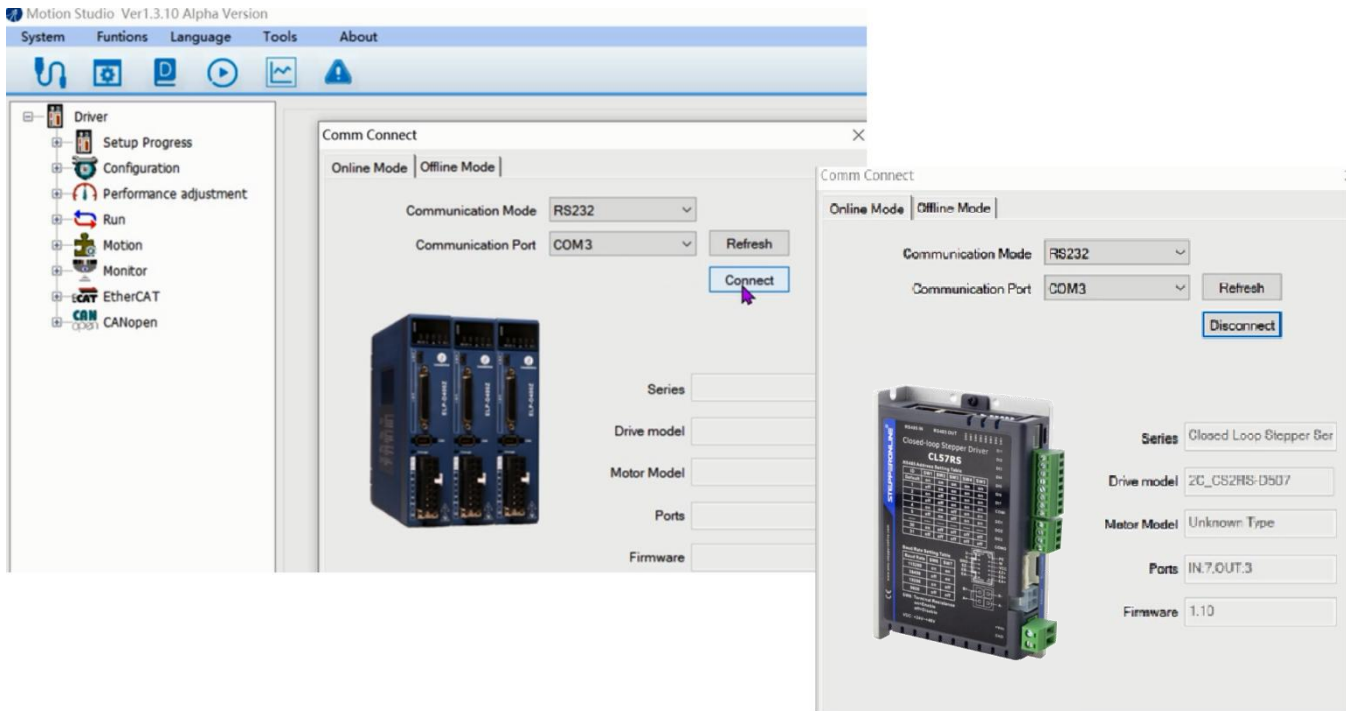

(5) Basic parameter setting

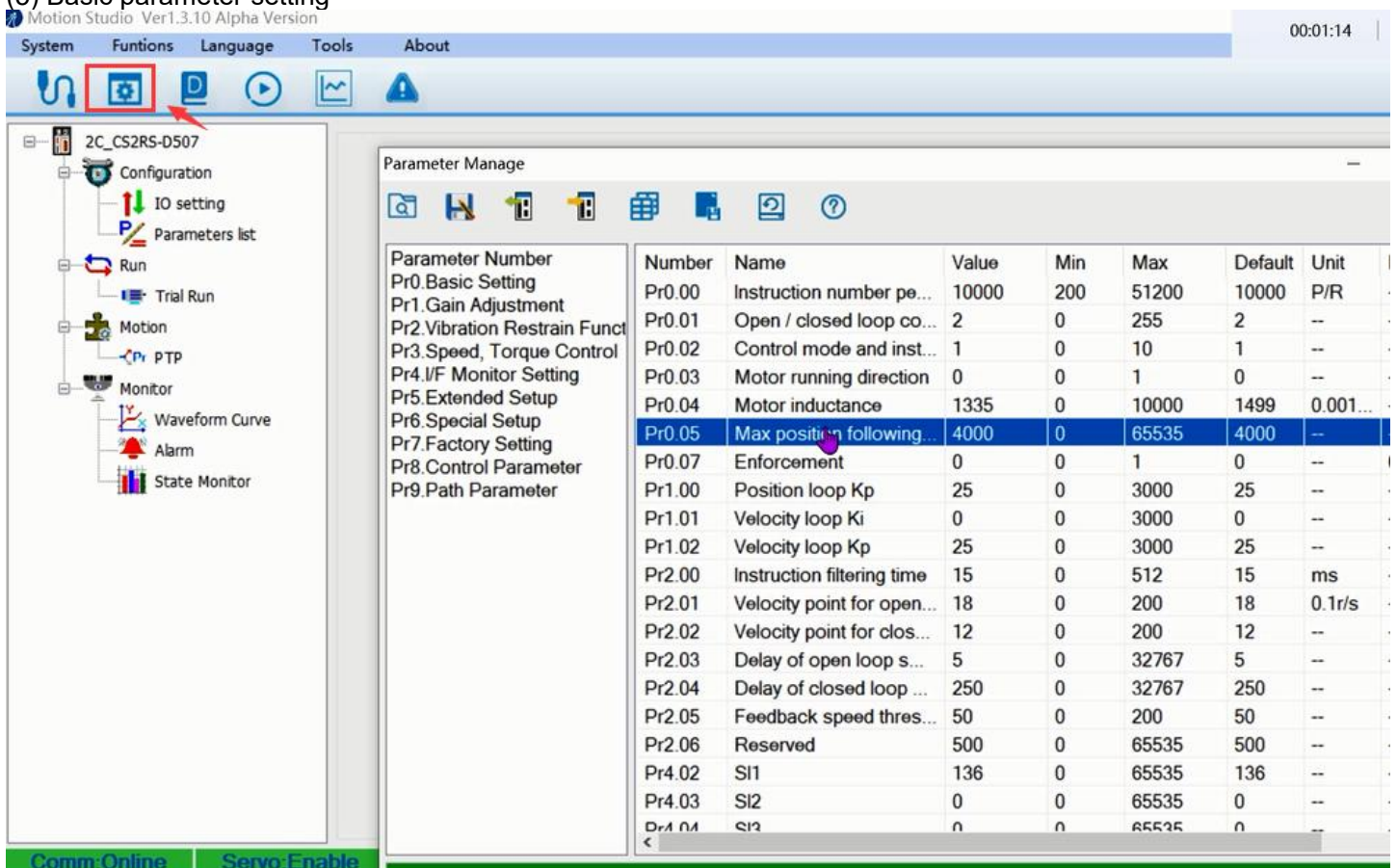

(6) Input and output function and polarity setting

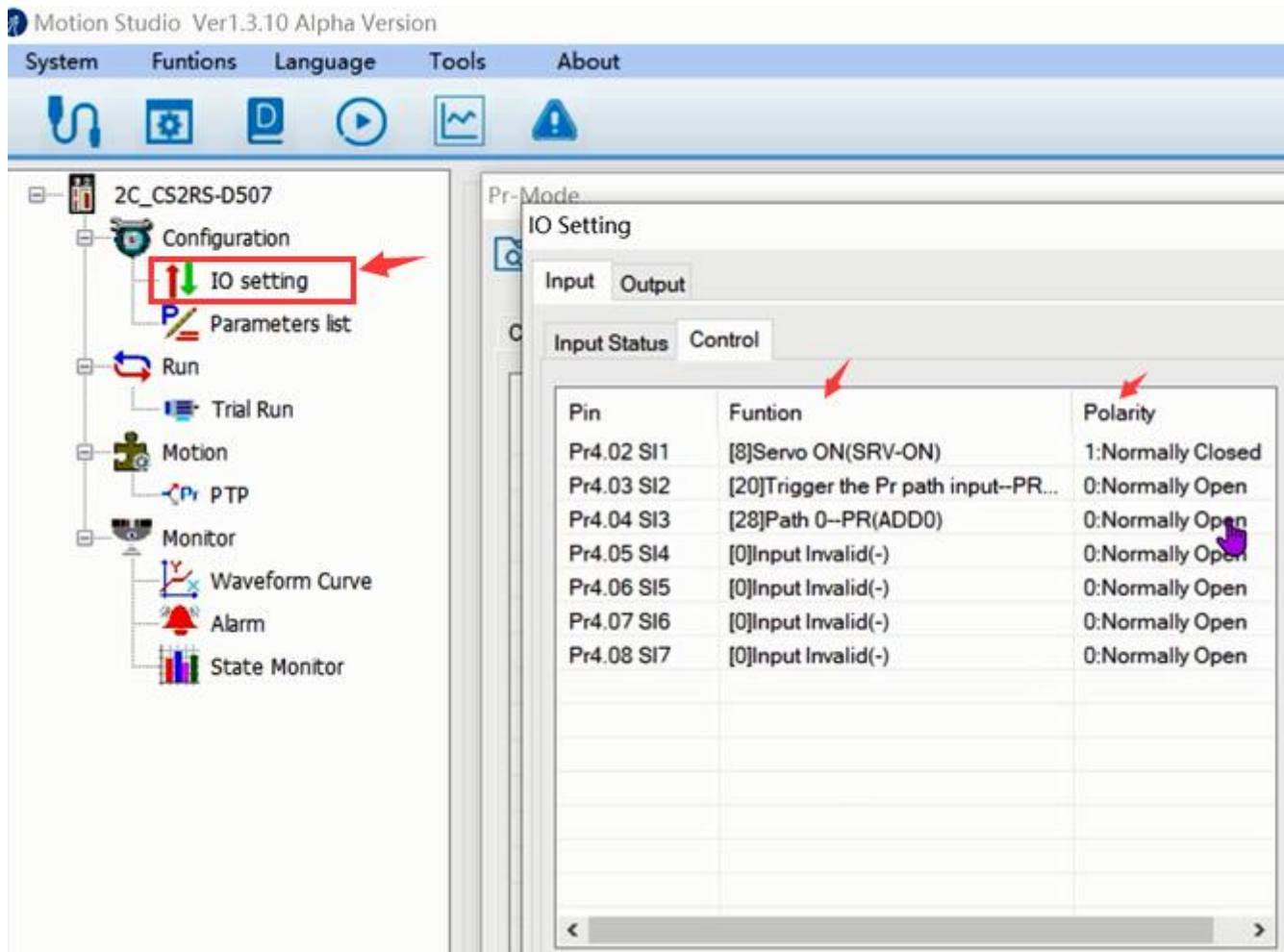

Note: After setting the parameters, click "OK". Then, in the parameter management window, click the Save button to prevent the parameter values from being lost after the drive is powered off.

Parameter Manage

Parameter Number	Number	Name	Value	Min	Max	Default	Unit
Pr0.Basic Setting	Pr6.15	Version information (...)	110	0	0	0	--
Pr1.Gain Adjustment	Pr6.16	Version information (s...	12810	0	0	0	--
Pr2.Vibration Restrain Funct	Pr7.01	Encoder resolution	4000	0	20000	4000	--
Pr3.Speed, Torque Control	Pr7.02	Back EMF coefficient	100	0	32767	100	1ms
Pr4.I/F Monitor Setting	Pr7.03	Current loop Kp	1500	0	32767	1500	--
Pr5.Extended Setup	Pr7.04	Current loop Ki	300	0	32767	300	--
Pr6.Special Setup	Pr7.05	Adjustment ratio of cu...	100	0	1024	100	--
Pr7.Factory Setting	Pr7.06	Current loop Kc	300	0	32767	300	--
Pr8.Control Parameter	Pr7.07	Weak magnetic coeffi...	0	0	255	0	--
Pr9.Path Parameter	Pr7.08	Weak magnetic coeffi...	0	0	255	0	--
	Pr7.09	Over voltage limit	90	0	1000	90	V
	Pr8.00	PR control setting	0	-32768	32767	0	--

6.1.2 Operation of Trial Run

Trial run lets the motor to achieve forward and reverse rotation, or repeat motion. The operation steps are as follows

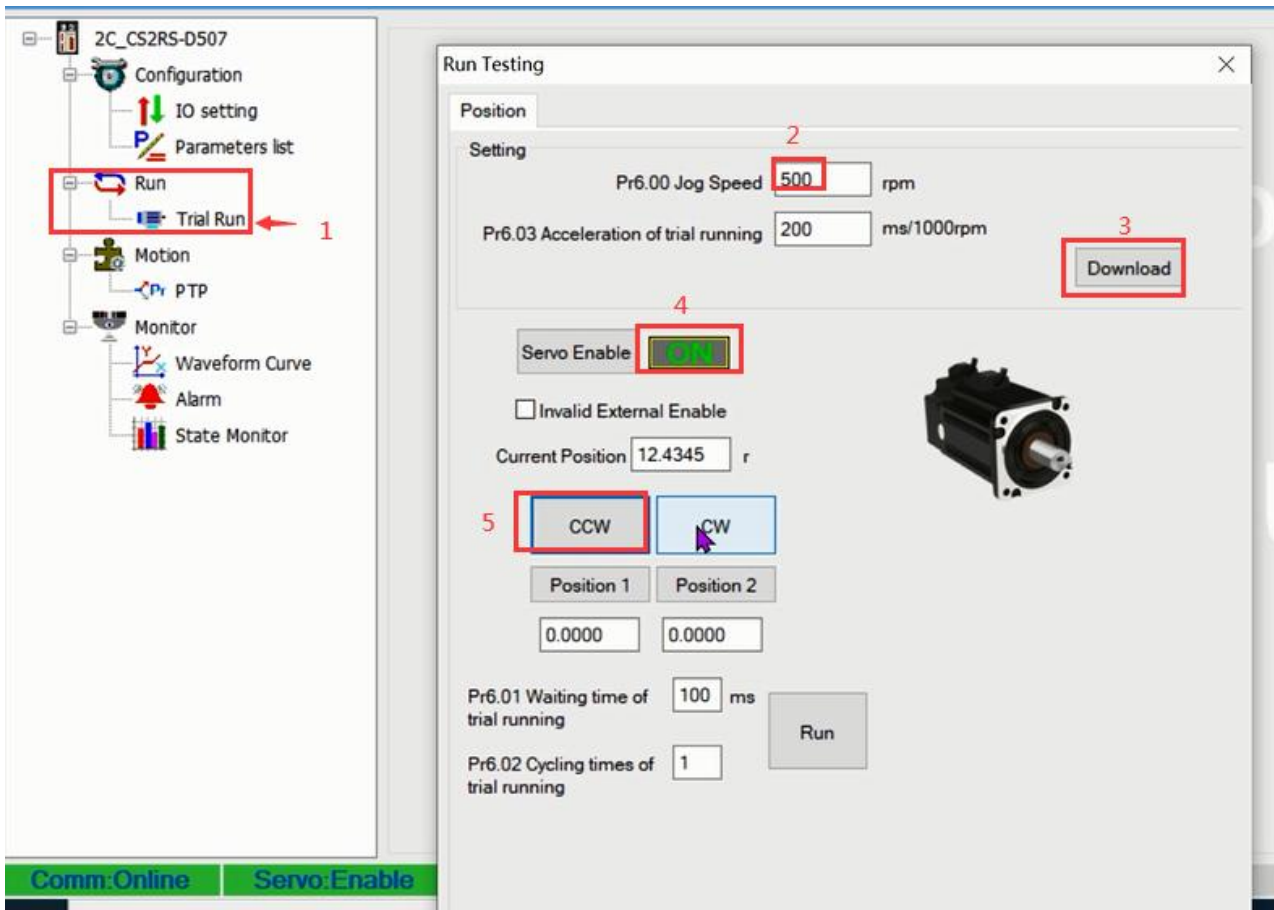

6.1.3 Operation of PR Function

(1) This window can set the CTGR trigger and Homing parameters of PR motion:

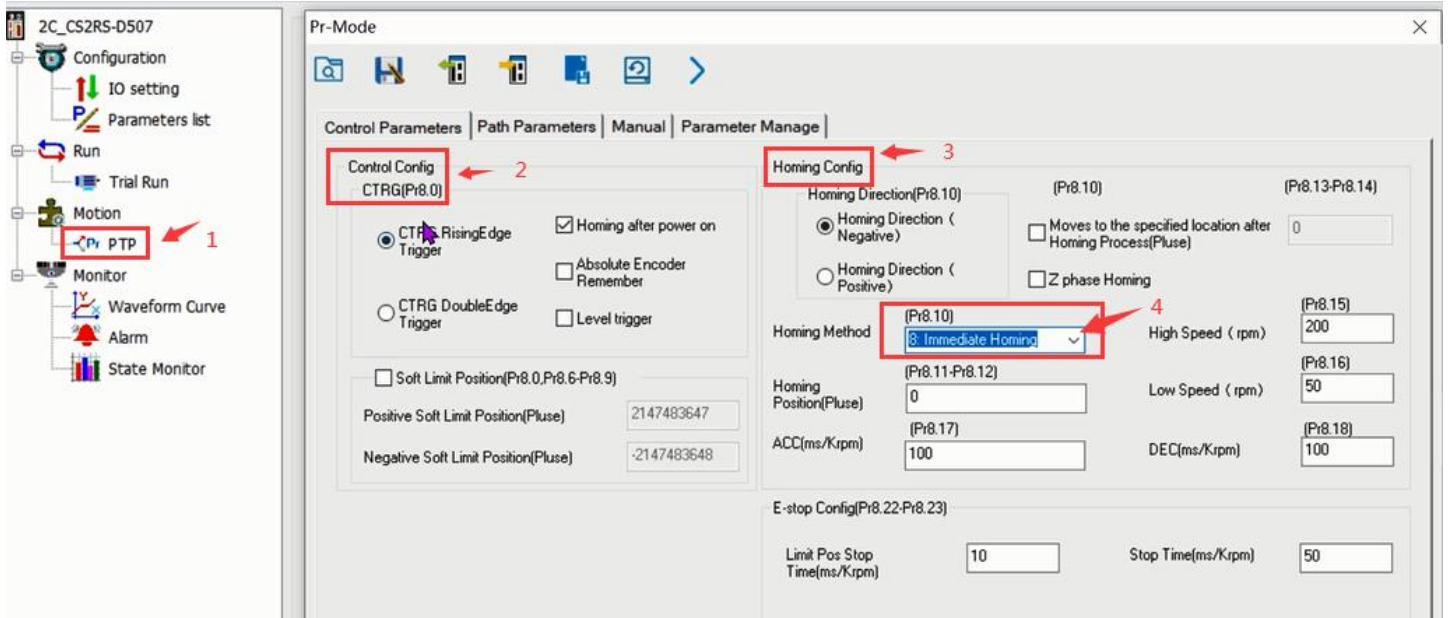

(2) This window is the PR path parameter setting, including operation mode, target position, speed value, etc. Double click to modify parameters.

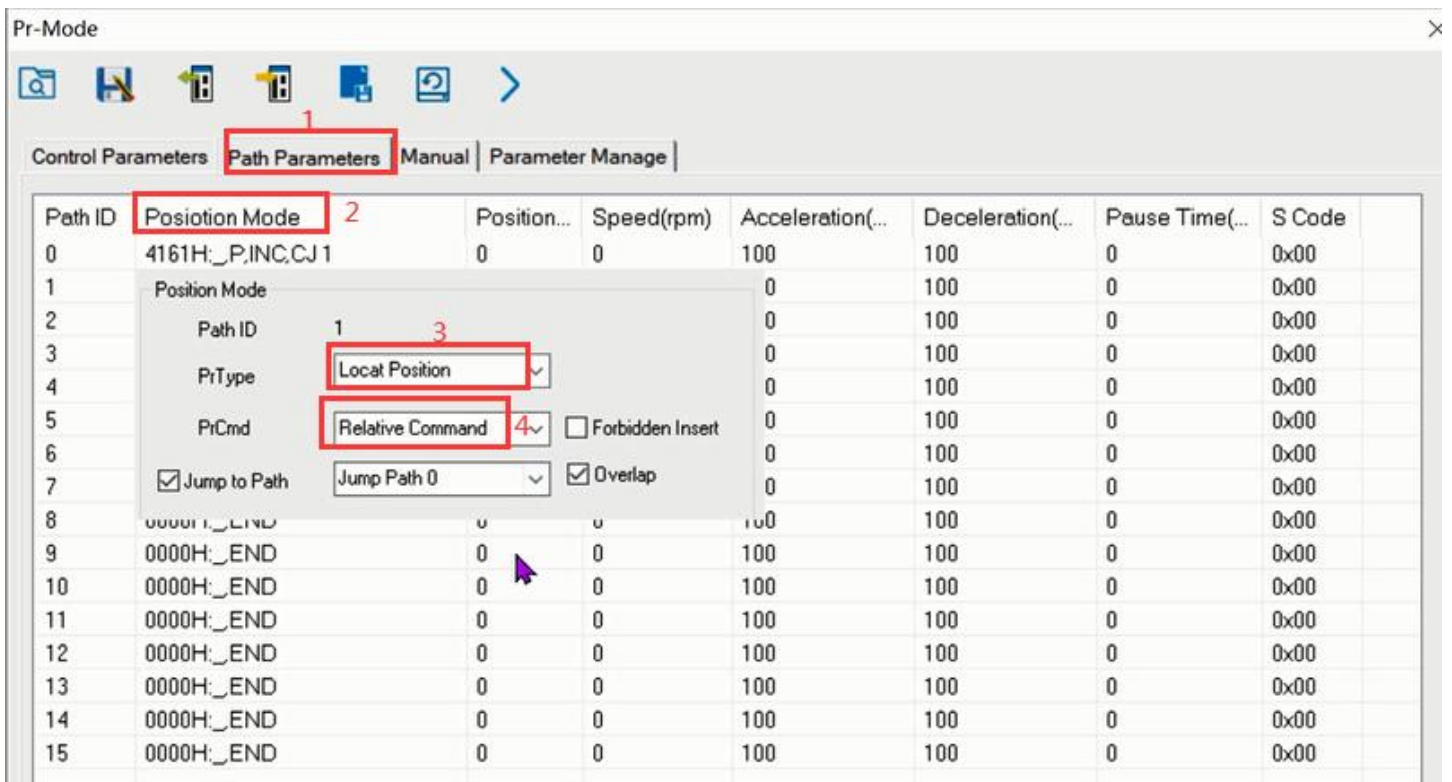

After the setting is completed, please click to download and save, as follows

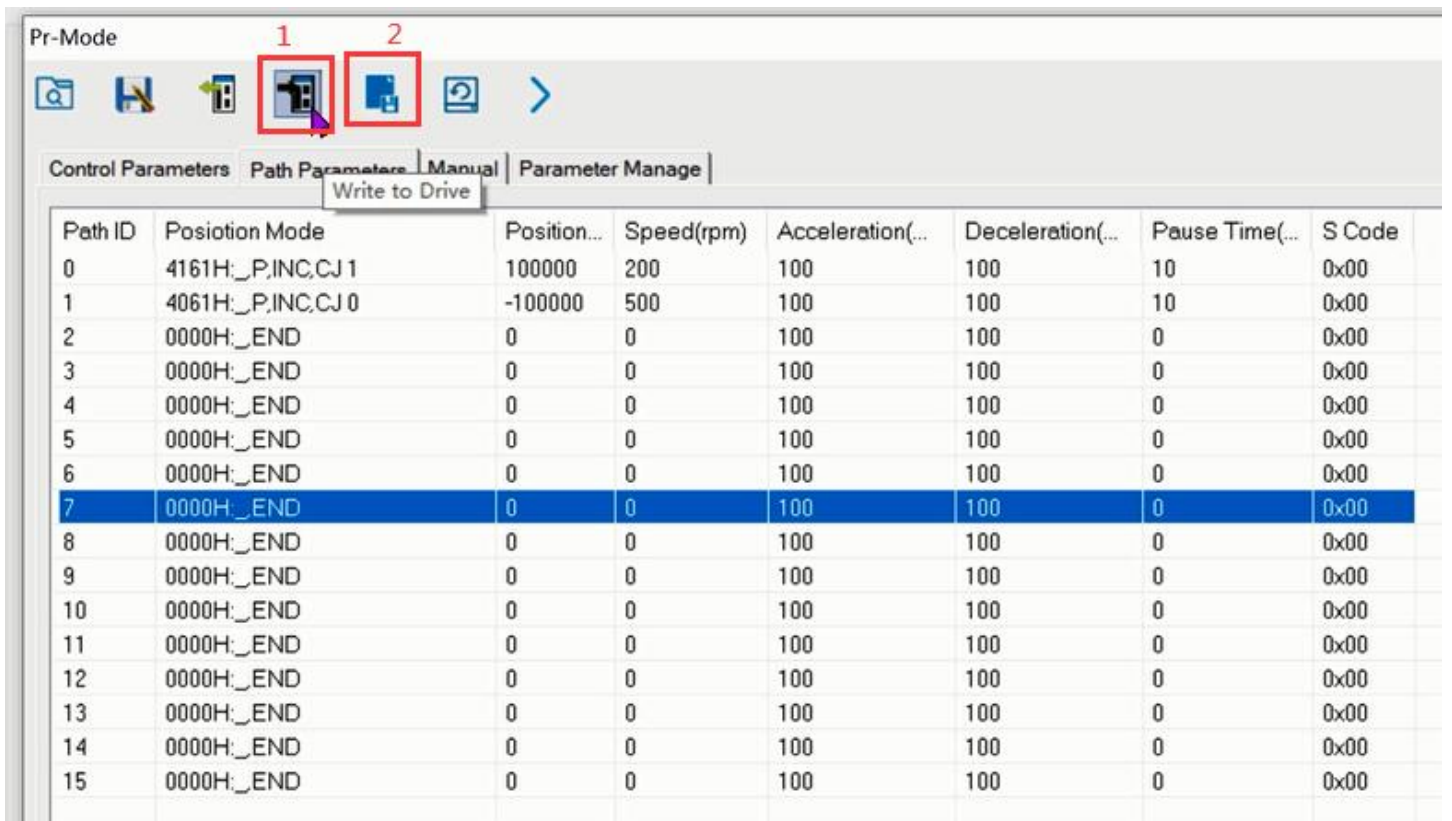

(3) Manually run the PR path

As shown in the figure below, the default is the motion parameter of PR0. As long as click Start, the motor will run according to the path of PR0. If click PR1 in step 4, the motor will be forced to switch to the path of PR1. Click step 3 to stop motor.

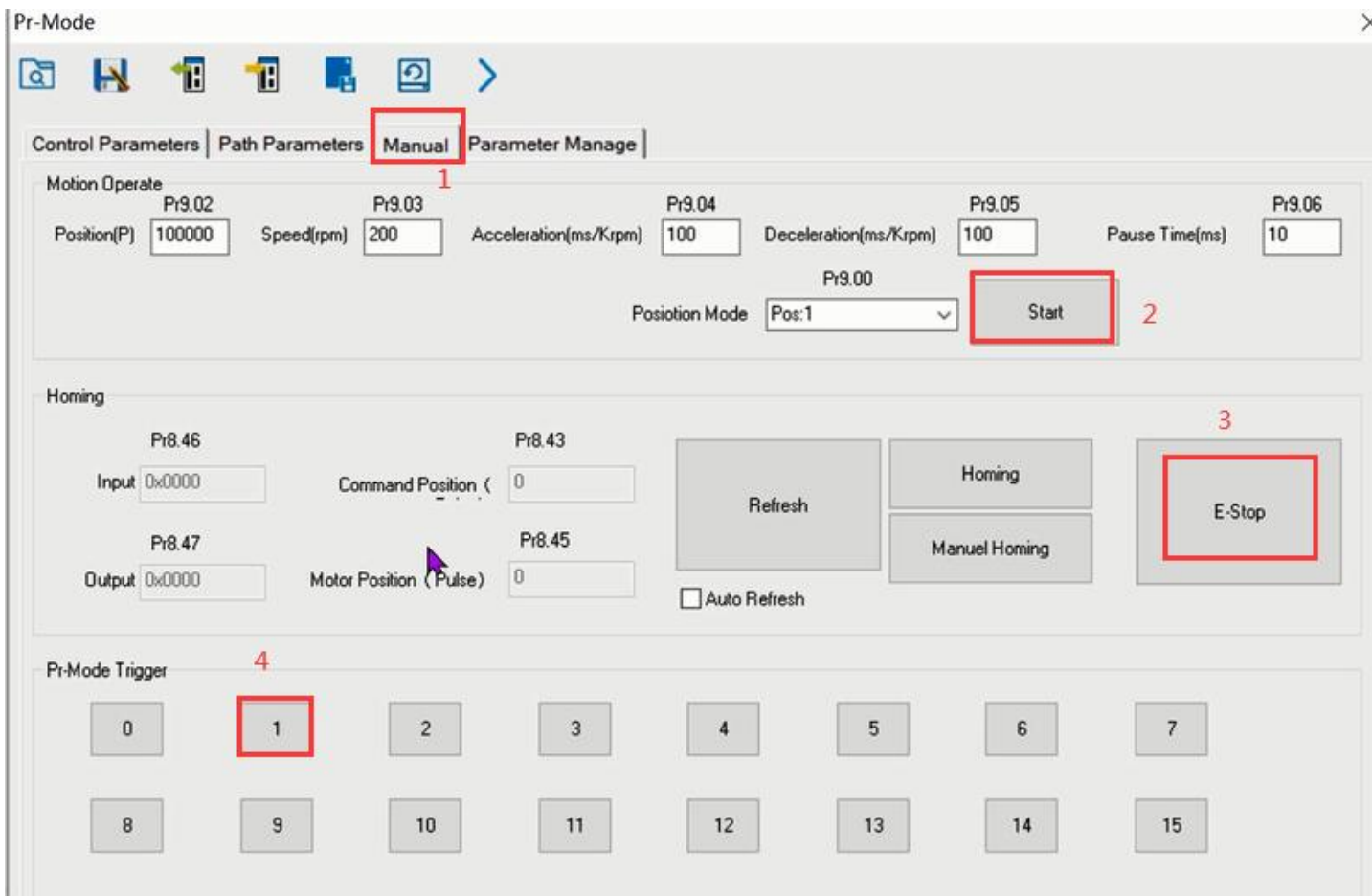

6.2 Basic Operation of Serial Port Tools Software

This is to control the motor through RS485 communication, user can realize the movement of the motor by sending commands to the corresponding registers.

6.2.1 Preparation and Steps

(1) RS485 tuning cable

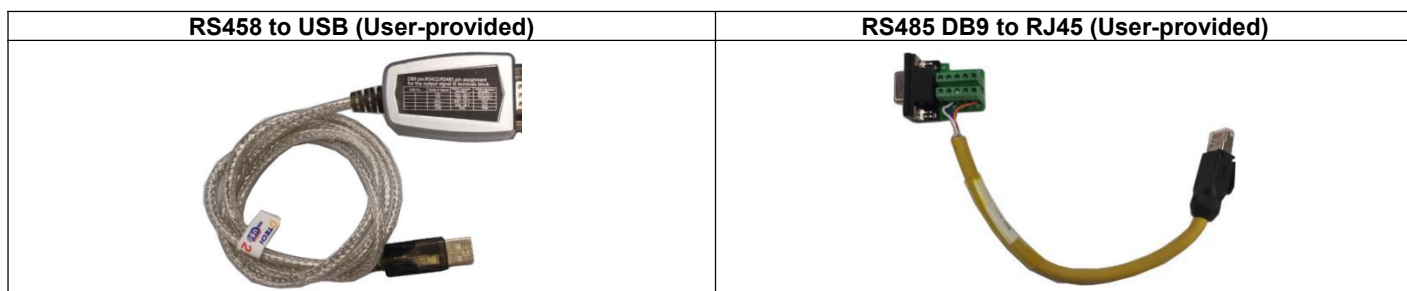

(2) COM port selection, as shown in the figure below, the communication port is COM3:

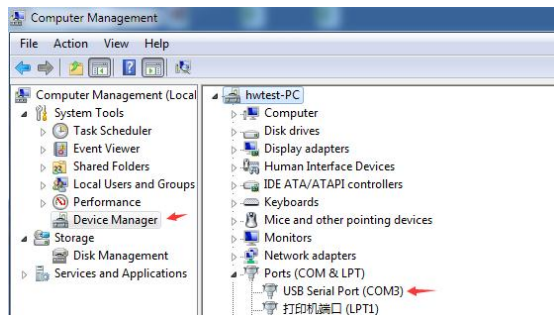

(4) Connect tuning software

Select COM3, select the same baud rate as the drive settings. After clicking connect.

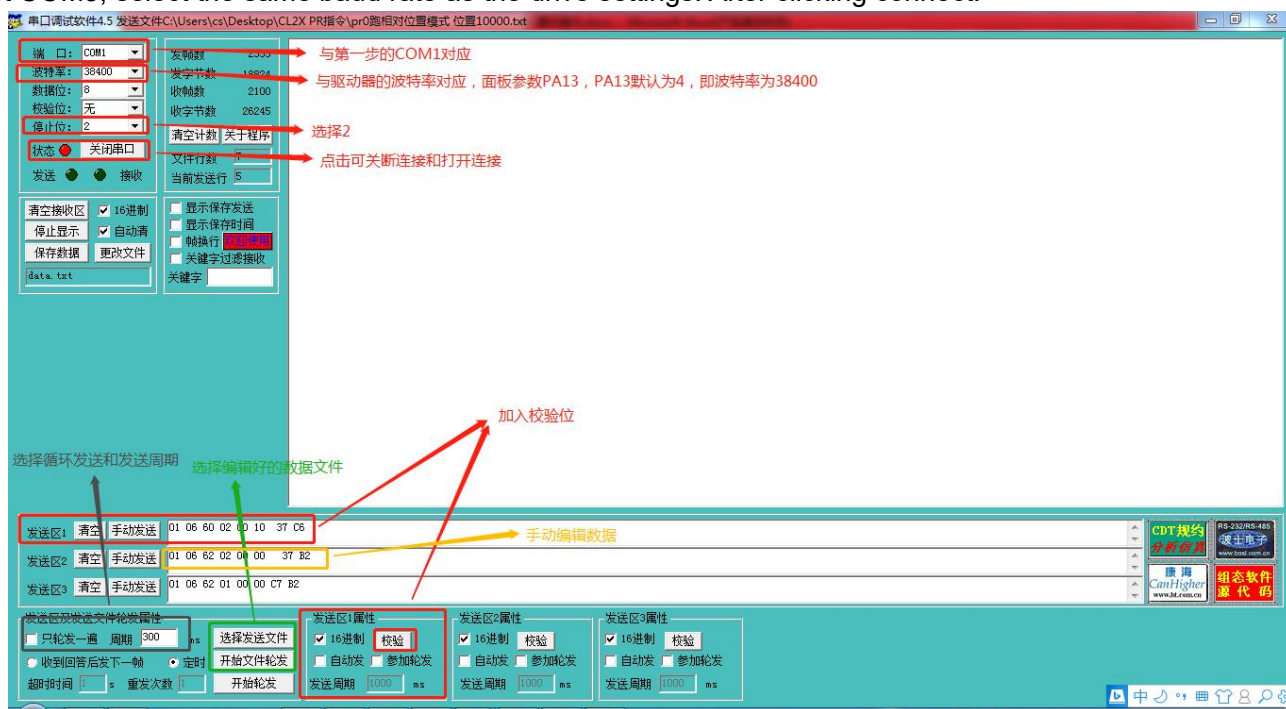

6.2.2 Operation Instruction Format

Data format: Here is an example of setting the PR0 path: (Data is in hexadecimal)

Slave ID	Function Code	Register Address	Value to Write	CRC
01	06 (Preset single register)	62 00 (PR0 operation mode setting)	00 41 (Set PR mode to relative position mode)	56 42 (Automatically generated by the serial port tool software)
A complete command 01 06 62 00 00 41 56 42				

6.2.3 Command Cases of Modbus RTU

(1) Set PR0 to go absolute position mode, running distance 200000p (microstep 10000)

Commands:

01 06 **62 00** 00 00 01 57 B2

Set PR0 mode to absolute position mode

01 06 62 01 00 03 87 B3	Set PR0 position high
01 06 62 02 0D 40 32 D2	Set PR0 position low
01 06 62 03 02 58 66 E8	Set PR0 speed value
01 06 62 04 00 32 56 66	Set PR0 acceleration
01 06 62 05 00 32 07 A6	Set PR0 deceleration velocity
01 06 60 02 00 10 37 C6	Trigger PR0 motion
Send when you need to stop:	
01 06 60 02 00 40 37 FA	Emergency stop

(2) Set PR0 to go relative position mode, running distance 10000p (microstep 10000)

Commands:

01 06 62 00 00 41 56 42	Set PR mode to relative position mode
01 06 62 01 00 00 C7 B2	Set PR0 position high
01 06 62 02 27 10 2D 8E	Set PR0 position low
01 06 62 03 02 58 66 E8	Set PR0 velocity
01 06 62 04 00 32 56 66	Set PR0 acceleration
01 06 62 05 00 32 07 A6	Set PR0 deceleration velocity
01 06 60 02 00 10 37 C6	Trigger PR0 motion
Send when you need to stop:	
01 06 60 02 00 40 37 FA	Emergency stop

(3) Set PR0 to go in velocity mode, velocity is 300rpm

Commands:

01 06 62 00 00 00 02 17 B3	Set PR0 to velocity mode
01 06 62 03 01 2C 66 3F	Set PR0 speed value
01 06 60 02 00 10 37 C6	Trigger PR0 motion
Send when you need to stop:	
01 06 60 02 00 40 37 FA	Emergency stop

(4) Set PR1 to go absolute position mode, running distance -200000p (microstep is 10000)

Commands:

01 06 62 08 00 01 D6 70	Set PR1 mode
01 06 62 09 FF FC 07 C1	Set PR1 position high
01 06 62 0A F2 C0 F3 40	Set PR1 position low
01 06 62 0B 02 58 E7 2A	Set PR1 speed value
01 06 62 0C 00 32 D7 A4	Set PR1 acceleration
01 06 62 0D 00 32 86 64	Set PR1 deceleration
01 06 60 02 00 11 F6 06	Trigger PR1 motion

Send when you need to stop:

01 06 60 02 00 40 37 FA	Emergency stop
-------------------------	----------------

(Note: -200000 is converted to hexadecimal as FFFCF2C0. You can enter the minus sign first, then 200000, and then enter the minus sign again to display FFFCF2C0)

(5) Set PR1 go velocity mode, speed value is 200rpm (microstep is 10000)

Commands:

01 06 62 08 00 02 96 71	Sets PR1 to velocity mode
01 06 62 0B 01 2C E7 FD	Set PR1 speed value
01 06 60 02 00 11 F6 06	Trigger PR1 motion
Send when you need to stop:	
01 06 60 02 00 40 37 FA	Emergency stop

(6) Homing

Commands:

01 06 60 0A 00 00 B7 C8	Set homing method
01 06 60 0F 00 64 A6 22	Set homing speed high
01 06 60 10 00 1E 16 07	Set homing speed low
01 06 60 02 00 20 37 D2	Trigger Homing

Appendix A Parameters List

1. Modbus RTU Parameters

The STEPPERONLINE RS485 parameter data type is 32-bit data, and a parameter contains two registers, high 16 bits and low 16 bits, but in practice most parameters only need to use the low 16 bits. When reading and writing multiple parameters in succession, the high 16 bits of the parameter need to be used as the start.

Register Address	Software Parameter No.	Name	Description	Range	Default Value	Unit
0x0001	Pr0.00	Pulse/revolution	10000	200-51200	10000	P/R
0x0003	Pr0.01	Control Mode	Value "0" for open loop; Value "2" for closed loop; Value "1" is reserved.	0-255	2	--
0x0007	Pr0.03	Motor direction	0: CW 1: CCW	0-1	0	--
0x0009	Pr0.04	Motor inductance	Invalid	0-10000	1499	0.001mH
0x000B	Pr0.05	Allowed max position following error	It's used to set the allowed max pulse count of position errors.	0-65535	4000	CPR
0x00F	Pr0.07	Forced enable by software	Software forced enable has a higher priority than IO enable, and when this value is 0, the enable status of the drive only depends on the IO signal. When this value is 1, the motor is enabled regardless of the IO signal status.	0-1	0	--
0x0051	Pr1.00	Position loop Kp	Increase this value will reduce position following error, but could result in motor vibration	0-3000	507:25 1008: 45	--
0x0053	Pr1.01	Velocity loop Ki	This parameter is used for tuning Velocity loop proportional gain.	0-3000	3	--
0x0055	Pr1.02	Velocity loop Kp	Increase the value can increase velocity stiffness	0-3000	507: 25 1008: 45	--
0x0065	Pr1.10	Position loop KpH	Usually keep default	0-3000	0	--
0x00A1	Pr2.00	Command filter time	To configure the time for internal command filtering	0-512	15	0.1ms
0x00A3	Pr2.01	Velocity switching point: open loop to closed loop	Usually keep the default value. Only change it when it causes motor vibration at this mode switching velocity point.	0-200	18	0.1RPS
0x00A5	Pr2.02	Velocity switching point: closed loop to open loop	Usually keep the default value.	0-200	12	0.1RPS
0x00A7	Pr2.03	Delay time of open loop to closed loop	Usually keep the default value.	0-32767	5	ms
0x00A9	Pr2.04	Delay time of closed loop to open loop	Usually keep the default value.	0-32767	250	ms
0x0145	Pr4.02	SI1(input 1)	Default is normal-open(N.O) type, it can be set to normal-closed(N.C) type by setting the corresponding port +0x80 SI1 is enable(default), N.C type input. 0: invalid; 7: alarm clearing; 8: enable (also can be set by 0x00F); 0x20: Trigger command; 0x21: Trigger homing; 0x22: EMG (quick stop); 0x23: JOG+; 0x24: JOG-; 0x25: POT (positive limit); 0x26: NOT (negative limit); 0x27: ORG (home switch); 0x28: ADD0 (path address 0); 0x29: ADD1 (path address 1); 0x2A: ADD2 (path address 2); 0x2B: ADD3 (path address 3); 0x2C: JOG velocity 2	0-65535	136 (0x88)	--
0x0147	Pr4.03	SI2(input 2)		0-65535	0	--
0x0149	Pr4.04	SI3(input 3)		0-65535	0	--
0x014B	Pr4.05	SI4(input 4)		0-65535	0	--
0x014D	Pr4.06	SI5(input 5)		0-65535	0	--
0x014F	Pr4.07	SI6(input 6)		0-65535	0	--
0x0151	Pr4.08	SI7(input 7)		0-65535	0	--
0x0157	Pr4.11	SO1(output 1)		Default is normal-open(N.O) type, it can be set to normal-closed(N.C) type by setting the corresponding port +0x80 0: invalid;	0-65535	0
0x0159	Pr4.12	SO2(output 2)	0x20: command completed; 0x21: path completed; 0x22: homing completed;	0-65535	0	--

0x015B	Pr4.13	SO3(output 3)	0x23: in-position completed; 0x24: brake output; 0x25: alarm output;	0-65535	0	--
0x0167	Pr4.19	Delay of brake released	Keep default normally	0-1500	250	ms
0x0169	Pr4.20	Delay of brake locked	Keep default normally	0-1500	250	ms
0x016B	Pr4.21	Threshold value of brake locking velocity	Keep default normally	0-500	10	--
0x016D	Pr4.22	Alarm detection selection	Bit setting: =1: Yes; =0: No bit0: over-current (Cannot be changed) bit1: over-voltage bit2: position following error bit3: ADC sampling failure bit4: Locked shaft alarm bit5: EEPROM alarm bit6: Auto-tuning alarm	0-65535	0	--
0x0171	Pr4.24	Distance to send "In Position" output signal	The distance (in number of pulses) to send out the In-Position signal	0-1500	200	CPR
0x0177	Pr4.27	Bus voltage		0-65535	0	0.1V
0x0179	Pr4.28	Digital input statue	Bit0-Bit6: SI1-SI7	0-65535	0	--
0x017B	Pr4.29	Digital output statue	Bit0-Bit2: SO1-SO3	0-65535	0	--
0x0187	Pr4.35	DIP switches statue		0-65535	0	--
0x0191	Pr5.00	Peak current	Approximately equal to motor phase current value multiplied by 1.2 -1.4	503: 3-30 507: 5-70 1008: 5-80	503: 25 507: 60 1008: 80	0.1A
0x0193	Pr5.01	Percentage of holding current in closed-loop mode	It is recommended to keep default, If the torque is not enough, it can be increased appropriately	0-100	50	%
0x0195	Pr5.02	Percentage of holding current in open-loop mode	It is recommended to keep default, If the torque is not enough, it can be increased appropriately	0-100	50	%
0x0197	Pr5.03	Percentage of shaft locked current(power on)	Keep default normally	0-100	100	--
0x0199	Pr5.04	Shaft locked duration	Keep default normally	0-1500	200	1ms
0x019F	Pr5.07	Rising time of shaft locked current (power on)	Keep default normally	1-60	1	100ms
0x01A5	Pr5.10	The max stop time	Keep default normally	100-1000	1000	ms
0x01AB	Pr5.13	Auto-tuning at power on	0: disable, 1: enable	0-1	1	--
0x01BD	Pr5.22	RS485 baud rate	0: 2400 1: 4800 2: 9600 (default) 3: 19200 4: 38400(factory) 5: 57600 6: 115200 When SW6 and SW7 are all OFF, it can be set by PC software.	0-6	4	--
0x01BF	Pr5.23	RS485 ID	When SW1 - SW5 are all ON, it can be set by PC software	0-127	1	--
0x01C1	Pr5.24	RS485 data type selection	0: 8-bit data, even check, 2 stop bits; 1: 8-bit data, odd check, 2 stop bits 2: 8-bit data, even check, 1 stop bit; 3: 8-bit data, odd check, 1 stop bit; 4: 8-bit data, no check,1 stop bit; 5: 8-bit data, no check,2 stop bits;	0-11	4	--
0x01C3	Pr5.25	RS485 control word		0-32767	0	--
0x01C4	Pr5.26	Communication bit delay		0-100	35	bit
0x01D1	Pr5.32	Switching time to standby		10-65535	200	ms
0x01D3	Pr5.33	Standby current percentage		0-100	50	
0x01E1	Pr6.00	JOG velocity	This JOG is triggered by RS485. For JOG triggered by IO, please use Pr8.40/8.41	0-5000	60	r/min
0x01E3	Pr6.01	Interval		0-10000	100	ms
0x01E5	Pr6.02	Running times		0-30000	1	--
0x01E7	Pr6.03	Acc. / Dec. time		0-10000	200	--
0x01FF	Pr6.15	Version information		Read only	0-65535	0
0x0201	Pr6.16	Firmware information	Read only	0-65535	0	--
0x0231	Pr7.00	Motor model	Invalid	0-100	0	--
0x0235	Pr7.02	Back EMF coefficient	Invalid	0-32767	100	1ms
0x0237	Pr7.03	Current loop proportional KP	Invalid	0-3000	1500	--
0x0239	Pr7.04	Current loop KI	It is recommended to keep the factory value, when disable auto-tuning, can be modified	0-1500	300	--
0x023B	Pr7.05	Current loop KP		0-1024	100	--
0x023D	Pr7.06	Current loop Kc	Invalid	0-32767	300	--
0x0243	Pr7.09	Over-voltage threshold	Invalid	0-1000	90	V

0x1003	-	Motion status	<table border="1"> <tr><td colspan="2">Read only:</td></tr> <tr><td>Bit NO.</td><td>Read value =1 means</td></tr> <tr><td>Bit0</td><td>Fault</td></tr> <tr><td>Bit1</td><td>Enable</td></tr> <tr><td>Bit2</td><td>Running</td></tr> <tr><td>Bit4</td><td>Command completed</td></tr> <tr><td>Bit5</td><td>Path completed</td></tr> <tr><td>Bit6</td><td>Homing completed</td></tr> </table>	Read only:		Bit NO.	Read value =1 means	Bit0	Fault	Bit1	Enable	Bit2	Running	Bit4	Command completed	Bit5	Path completed	Bit6	Homing completed	-	--		
Read only:																							
Bit NO.	Read value =1 means																						
Bit0	Fault																						
Bit1	Enable																						
Bit2	Running																						
Bit4	Command completed																						
Bit5	Path completed																						
Bit6	Homing completed																						
0x1801	-	Control word	<table border="1"> <tr><td>Write value</td><td>Function</td></tr> <tr><td>0x1111</td><td>Reset current alarm</td></tr> <tr><td>0x1122</td><td>Reset history alarm</td></tr> <tr><td>0x2211</td><td>Save all parameters to EEPROM</td></tr> <tr><td>0x2222</td><td>Parameter reset(exclude motor parameters)</td></tr> <tr><td>0x2233</td><td>All parameters are reset to factory</td></tr> <tr><td>0x2244</td><td>Save all mappings into EEPROM</td></tr> <tr><td>0x4001</td><td>JOG CW (Need to write once at least 50ms)</td></tr> <tr><td>0x4002</td><td>JOG CCW (Need to write once at least 50ms)</td></tr> </table>	Write value	Function	0x1111	Reset current alarm	0x1122	Reset history alarm	0x2211	Save all parameters to EEPROM	0x2222	Parameter reset(exclude motor parameters)	0x2233	All parameters are reset to factory	0x2244	Save all mappings into EEPROM	0x4001	JOG CW (Need to write once at least 50ms)	0x4002	JOG CCW (Need to write once at least 50ms)	-	--
Write value	Function																						
0x1111	Reset current alarm																						
0x1122	Reset history alarm																						
0x2211	Save all parameters to EEPROM																						
0x2222	Parameter reset(exclude motor parameters)																						
0x2233	All parameters are reset to factory																						
0x2244	Save all mappings into EEPROM																						
0x4001	JOG CW (Need to write once at least 50ms)																						
0x4002	JOG CCW (Need to write once at least 50ms)																						
0x1901	-	Save parameter status word	<table border="1"> <tr><td colspan="2">Read only</td></tr> <tr><td>Read Value</td><td>Means</td></tr> <tr><td>0x5555</td><td>Save successfully</td></tr> <tr><td>0xAAAA</td><td>Failed to save</td></tr> </table>	Read only		Read Value	Means	0x5555	Save successfully	0xAAAA	Failed to save	-	--										
Read only																							
Read Value	Means																						
0x5555	Save successfully																						
0xAAAA	Failed to save																						
0x2203	-	Current alarm	<table border="1"> <tr><td colspan="2">Read only</td></tr> <tr><td>Error code</td><td>Means</td></tr> <tr><td>0x01</td><td>Over- current</td></tr> <tr><td>0x02</td><td>Over- voltage</td></tr> <tr><td>0x40</td><td>Current sampling fault</td></tr> <tr><td>0x80</td><td>Failed to lock shaft</td></tr> <tr><td>0x200</td><td>EEPROM fault</td></tr> <tr><td>0x100</td><td>Auto-tuning fault</td></tr> </table>	Read only		Error code	Means	0x01	Over- current	0x02	Over- voltage	0x40	Current sampling fault	0x80	Failed to lock shaft	0x200	EEPROM fault	0x100	Auto-tuning fault	-	--		
Read only																							
Error code	Means																						
0x01	Over- current																						
0x02	Over- voltage																						
0x40	Current sampling fault																						
0x80	Failed to lock shaft																						
0x200	EEPROM fault																						
0x100	Auto-tuning fault																						

2. PR Parameters:

PR parameter data type is 16-bit data, one parameter occupies one register (one 16-bit register = 2 8-bit bytes).

Parameter NO. in PC software	Register Address	Name	Description
Pr8.00	0x6000	PR global control function	Bit0: CTRG effective edge. 0--rising edge, 1--double edges Bit1: Soft limit.. 0--disable, 1--enable Bit2: Homing after power on. 0--no, 1--yes Bit4: CTRG trigger type. 0--refer to bit0, 1--level trigger
Pr8.02	0x6002	PR control register	(1) Write commands to 0x6002 to select and trigger each action: Write 0x1P ("P" = 0-15), run the path P motion; Write 0x20, homing; Write 0x21, manually set to zero position; Write 0x40, quick stop; (2) Read 0x6002 can check the running path NO. and status: Return "0x000P", path P motion complete, can receive new motion command; Return "0x001P or 0020 or 0040", not yet responding to commands; Return 0x010P, path P motion is running; Return 0x0200, command completed and waiting for positioning; Return 0x020P, a position following error during path P;
Pr8.06	0x6006	Limit+ H	Soft limit positive high bits
Pr8.07	0x6007	Limit+ L	Soft limit positive low bits
Pr8.08	0x6008	Limit- H	Soft limit negative high bits
Pr8.09	0x6009	Limit- L	Soft limit negative low bits

Pr8.10	0x600A	Homing mode	Bit0: homing direction, 0--CW, 1--CCW; Bit1: Whether to move to the specified position after homing, 0--no, 1--yes; Bit2- bit3: homing method, 00--limit switch homing, 01--home switch homing, 10--Z signal homing Note: (1) Write 0x21 to 0x6002, manually set the current point to zero position) (2) Other methods are not valid
Pr8.14	0x600E	homing stop position L	
Pr8.15	0x600F	Homing high velocity	The 1 st segment velocity of homing, unit: rpm
Pr8.16	0x6010	Homing low velocity	The 2 nd segment velocity of homing, unit: rpm
Pr8.17	0x6011	Homing Acc	Acc of homing, unit: ms/1000rpm
Pr8.18	0x6012	Homing Dec	Dec of homing, unit: ms/1000rpm
Pr8.19	0x6013	Torque zero return time	Torque retention time for torque zero return, unit ms
Pr8.20	0x6014	homing torque	Torque value of homing with torque detect
Pr8.21	0x6015	Homing over-travel	If setting a value, the motor stops when reaches this set distance even if homing is not completed.
Pr8.22	0x6016	Limit switch Dec. time	Deceleration time after reaching limit switch, unit: ms
Pr8.23	0x6017	STOP time	Deceleration time after quick stop, unit: ms
Pr8.26	0x601A	IO combination trigger mode selection	0: Disable IO combination triggering (factory) 1: Enable IO combination triggering, activated after homing is completed 2: Enable IO combination triggering, nothing to do with homing (recommended)
Pr8.27	0x601B	IO combination filter time	Unit: ms
Pr8.28	0x601C	S code current output value	--
Pr8.29	0x601D	PR alarm	0: Automatic zeroing of new commands 0x100: Limit switch error during homing 0x102: Homing over-travel error 0x20P: Limit switch error in Path P (P=1-15) 0x300: Touch limit switch during JOG movement
Pr8.38	0x6026	JOG velocity 2	JOG triggered by external I/O signal, Unit: rpm
Pr8.39	0x6027	JOG velocity	Unit: rpm
Pr8.40	0x6028	JOG Acceleration	Unit: ms/1000rpm
Pr8.41	0x6029	JOG Deceleration	Unit: ms/1000rpm
Pr8.42	0x602A	Profile position H	Read only. High 16-bit (0-65535), it will be cleared after successful homing
Pr8.43	0x602B	Profile position L	Read only. Low 16-bit (0-65535), it will be cleared after successful homing
Pr8.44	0x602C	Actual position H	Read only. High 16-bit (0-65535), it will be cleared after successful homing
Pr8.45	0x602D	Actual position L	Read only. Low 16-bit (0-65535), it will be cleared after successful homing
Pr8.48	0x6030	S-code output setting for Path 0	
Pr8.49	0x6031	S-code output setting for Path 1	
Pr8.50	0x6032	S-code output setting for Path 2	
Pr8.51	0x6033	S-code output setting for Path 3	
Pr8.52	0x6034	S-code output setting for Path 4	
Pr8.53	0x6035	S-code output setting for Path 5	
Pr8.54	0x6036	S-code output setting for Path 6	
Pr8.55	0x6037	S-code output setting for Path 7	
Pr8.56	0x6038	S-code output setting for Path 8	
Pr8.57	0x6039	S-code output setting for Path 9	
Pr8.58	0x603A	S-code output setting for Path 10	
Pr8.59	0x603B	S-code output setting for Path 11	
Pr8.60	0x603C	S-code output setting for Path 12	
Pr8.61	0x603D	S-code output setting for Path 13	
Pr8.62	0x603E	S-code output setting for Path 14	
Pr8.63	0x603F	S-code output setting for Path 15	

Pr9.00	0x6200	Motion of Path 0	<p>The corresponding functions can be selected for different bit</p> <p>Bit0-3: TYPE, =0---- no action =1---- position positioning =2---- velocity movement =3---- homing;</p> <p>Bit4: INS, =0---- No interrupt =1---- interrupt (all the current ones are 1.);</p> <p>Bit5: OVLP, =0---- Non overlapping =1---- Overlapping</p> <p>Bit6: =0----absolute position =1----relative Commands</p> <p>Bit8-13: Jump to the corresponding PR path 0-15; bit14: JUMP, =0---- No jump =1---- jump</p>
Pr9.01	0x6201	Position H	High 16 bit,
Pr9.02	0x6202	Position L	Low 16 bit
Pr9.03	0x6203	velocity	Unit: rpm
Pr9.04	0x6204	Acc	Unit: ms/1000rpm
Pr9.05	0x6205	Dec	Unit: ms/1000rpm
Pr9.06	0x6206	Pause time	Pause time after the command is stopped
Pr9.07	0x6207	Special parameter	PR Path 0 maps directly to Pr8.02, Others are reserved
Pr9.08	0x6208	Motion of Path 1	---
Pr9.09	0x6209	Position H	---
Pr9.10	0x620A	Position L	---
Pr9.11	0x620B	velocity	---
Pr9.12	0x620C	Acc	---
Pr9.13	0x620D	Dec	---
Pr9.14	0x620E	Pause time	---
Pr9.15	0x620F	Special parameter	---
Pr9.16	0x6210	Motion of Path 2	---
Pr9.17	0x6211	Position H	---
Pr9.18	0x6212	Position L	---
Pr9.19	0x6213	velocity	---
Pr9.20	0x6214	Acc	---
Pr9.21	0x6215	Dec	---
Pr9.22	0x6216	Pause time	---
Pr9.23	0x6217	Special parameter	---
Pr9.24- Pr9.31	Similar as above paths	Similar as above paths	Each path has 8 data
Pr9.32- Pr9.39	Similar as above paths	Similar as above paths	Each path has 8 data
Pr9.40- Pr9.47	Similar as above paths	Similar as above paths	Each path has 8 data
Pr9.48- Pr9.55	Similar as above paths	Similar as above paths	Each path has 8 data
Pr9.56- Pr9.63	Similar as above paths	Similar as above paths	Each path has 8 data
Pr9.64- Pr9.71	Similar as above paths	Similar as above paths	Each path has 8 data